



# MORRIS

**W7367SP**  
**S7368SP**

Please read this manual carefully before use this product

## USER MANUAL

**MINI BAR**

# CONTENTS

<b>1 Safety warnings</b>	
1.1 Warning	1-2
1.2 Meaning of safety warning symbols	3
1.3 Electricity related warnings	3
1.4 Related warnings for use	4
1.5 Warnings related to placing items	5
1.6 Warnings for energy	5
1.7 Warnings related to disposal	5
<b>2 Proper use of refrigerator</b>	
2.1 Names of components	6
2.2 Thermostat knob	7
2.3 Placement	7
2.4 Start to use	7
2.5 Energy saving tips	7
2.6 Door right-left change	8
<b>3 Maintenance of refrigerator</b>	
3.1 Cleaning	10
3.2 Defrost	10
3.3 Stop using	10
<b>4 Trouble shooting</b>	<b>12</b>
<b>5 Parameters</b>	<b>13</b>

## DEAR CUSTOMER:

Thank you for buying this refrigerator. To ensure that you get the best results from your new refrigerator, please take time to read through the simple instructions in this booklet. Please ensure that the packing material is disposed of in accordance with the current environmental requirements.

When disposing of any refrigerator equipment please contact your local waste disposal department for advice on safe disposal. This appliance must be only used for its intended purpose.

## 1 Safety warnings

### 1.1 Warning



**Warning:** risk of fire / flammable materials

**This** appliance is intended to be used in household and similar applications such as staff kitchen areas in shops, offices and other working environments; farm houses and by clients in hotels, motels and other residential type environments; bed and breakfast type environments; catering and similar non-retail applications.

**This** appliance is not intended for use by persons (including children) with reduced physical, sensory or mental capabilities, or lack of experience and knowledge, unless they have been given supervision or instruction concerning use of the appliance by a person responsible for their safety.)

**Children** should be supervised to ensure that they do not play with the appliance.

**If** the supply cord is damaged, it must be replaced by the manufacturer, its service agent or similarly qualified persons in order to avoid a hazard.

**Do** not store explosive substances such as aerosol cans with a flammable propellant in this appliance.

**The** appliance has to be unplugged after use and before carrying out user maintenance on the appliance.

**Warning:** Keep ventilation openings, in the appliance enclosure or in the built-in structure, clear of obstruction.

**Warning:** Do not use mechanical devices or other means to accelerate the defrosting process, other than those recommended by the manufacturer.

**Warning:** Do not damage the refrigerant circuit.

**Warning:** Do not use electrical appliances inside the food storage compartments of the appliance, unless they are of the type recommended by the manufacturer.

**Warning:** Please abandon the refrigerator according to local regulators for its use of flammable blowing gas and refrigerant.

**Warning:** When positioning the appliance, ensure the supply cord is not trapped or damaged.

**Warning:** Do not locate multiple portable socket-outlets or portable power supplies at the rear of the appliance.

**Do** not use extension cords or ungrounded ( two prong ) adapters.

**Danger:** Risk of child entrapment. Before you throw away your old refrigerator or freezer:

–Take off the doors.

–Leave the shelves in place so that children may not easily climb inside.

**The** refrigerator must be disconnected from the source of electrical supply before attempting the installation of accessory.

**Refrigerant** and cyclopentane foaming material used for the appliance are flammable. Therefore, when the appliance is scrapped, it shall be kept away from any fire source and be recovered by a special recovering company with corresponding qualification other than be disposed by combustion, so as to prevent damage to the environment or any other harm.

**The** necessity that, for doors or lids fitted with locks and keys, the keys be kept out of the reach of children and not in the vicinity of the refrigerating appliance, in order to prevent children from being locked inside .

**For** EN standard: This appliance can be used by children aged from 8 years and above and persons with reduce physical sensory or mental capabilities or lack of experience and knowledge if they have been given supervision or instruction concerning use of the appliance in a safe way and understand the hazards involved. Children shall not play with the appliance. Cleaning and user maintenance shall not be made by children without supervision. Children aged from 3 to 8 years are allowed to load and unload refrigerating appliances.

**To** avoid contamination of food, please respect the following instructions:

- Opening the door for long periods can cause a significant increase of the temperature in the compartments of the appliance.
  - Clean regularly surfaces that can come in contact with food and accessible drainage systems.
  - Clean water tanks if they have not been used for 48 h; flush the water system connected to a water supply if water has not been drawn for 5 days. (note 1)
  - Store raw meat and fish in suitable containers in the refrigerator, so that it is not in contact with or drip onto other food.
  - Two-star \*\* frozen-food compartments are suitable for storing pre-frozen food, storing or making ice-cream and making ice cubes. (note 2)
  - One \*, two \*\*, and three-star \*\*\* compartments are not suitable for the freezing of fresh food. (note 3)
  - For appliances without a 4-star compartment: this refrigerating appliance is not suitable for freezing foodstuffs. (note 4)
  - If the refrigerating appliance is left empty for long periods, switch off, defrost, clean, dry, and leave the door open to prevent mould developing within the appliance.
- Note 1,2,3,4: Please confirm whether it is applicable according to your product compartment type.



**For** a freestanding appliance: this refrigerating appliance is not intended to be used as a built-in appliance.

**Warning:** To avoid a hazard due to instability of the appliance, it must be fixed in accordance with the instructions.

**Warning:** Connect to potable water supply only. (Suitable for ice making machine)

**To** Prevent A Child From Being Entrapped, Keep Out Of Reach Of Children And Not In The Vicinity Of Freezer (Or Refrigerator). (Suitable for products with locks)

## 1.2 Meaning of safety warning symbols

	The symbols indicate prohibited matters, and those behaviors are forbidden. Non-compliance with the instructions may result in product damages or endanger the personal safety of users.
	The symbols indicate matters that must be followed, and those behaviors must be strictly executed in line with the operation requirements. Non-compliance with the instructions may result in product damages or endanger the personal safety of users.
	The symbols indicate matters to pay attention to, and these behaviors shall be specially noted. Due precautions are needed or minor or moderate injuries or damages of the product will be caused.

This manual contains lots of important safety information which shall be observed by the users.

## 1.3 Electricity related warnings

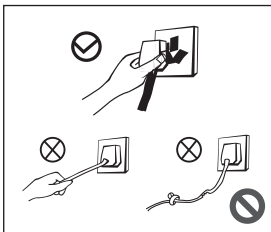

- Do not pull the power cord when pulling the power plug of the refrigerator. Please firmly grasp the plug and pull out it from the socket directly.
- Do not damage the power cord under any condition so as to ensure safety use, do not use when the power cord is damaged or the plug is worn.
- Worn or damaged power cord shall be replaced in manufacturer-authorized maintenance stations.

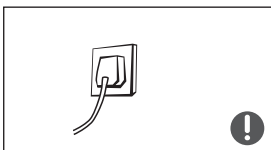

- The power plug should be firmly contacted with the socket or else fires might be caused. Please ensure that the grounding electrode of the power socket is equipped with a reliable grounding line.

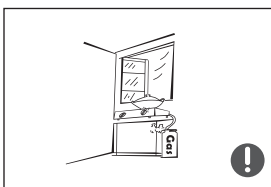

- Please turn off the valve of the leaking gas and then open the doors and windows in case of leakage of gas and other flammable gases. Do not unplug the refrigerator and other electrical appliances considering that spark may cause a fire.

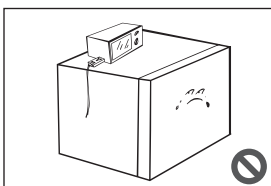

- To ensure safety, it is not recommended that to place regulators, rice cookers, microwave ovens and other appliances on the top of the refrigerator, those recommended by the manufacturer are not included. Do not use electrical appliances in the food pan.

## 1.4 Related warnings for use

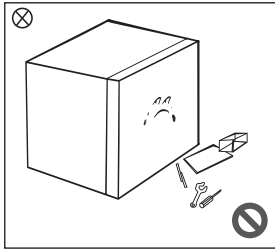

- Do not arbitrarily disassemble or reconstruct the refrigerator, nor damage the refrigerant circuit; maintenance of the appliance must be conducted by a specialist.
- Damaged power cord must be replaced by the manufacturer, its maintenance department or related professionals in order to avoid danger.

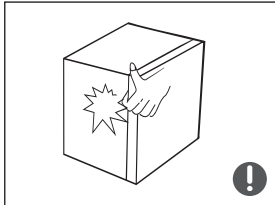

- The gaps between refrigerator doors and between doors and refrigerator body are small, be noted not to put your hand in these areas to prevent from squeezing the finger. Please be gentle when open the refrigerator door to avoid falling articles.
- Do not pick foods or containers with wet hands in the freezing chamber when the refrigerator is running, especially metal containers in order to avoid frostbite.

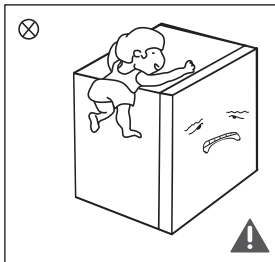

- Do not allow children to enter or climb the refrigerator to prevent that children are sealed in the refrigerator or children are injured by the falling refrigerator.
- Do not spray or wash the refrigerator; do not put the refrigerator in moist places easy to be splashed with water so as not to affect the electrical insulation properties of the refrigerator.

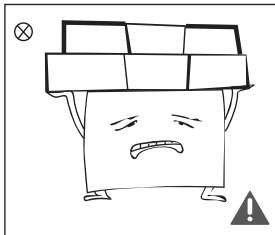

- Do not place heavy objects on the top of the refrigerator considering that objects may fall when open the door, and accidental injuries might be caused.
- Please pull out the plug in case of power failure or cleaning. Do not connect the refrigerator to power supply within five minutes to prevent damages to the compressor due to successive starts.

## 1.5 Warnings related to placing items

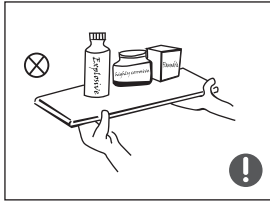

- Do not put flammable, explosive, volatile and highly corrosive items in the refrigerator to prevent damages to the product or fire accidents.
- Do not place flammable items near the refrigerator to avoid fires.

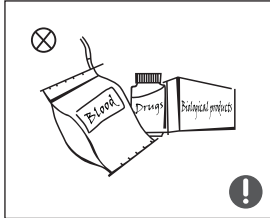

- This product is household refrigerator and shall be only suitable for the storage of foods. According to national standards, household refrigerator shall not be used for other purposes, such as storage of blood, drugs or biological products.

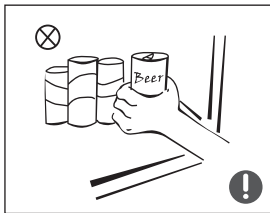

- Do not place items such as bottled or sealed container of fluid such as bottled beers and beverages in the refrigerator to prevent bursts and other losses.

## 1.6 Warnings for energy

- 1) Refrigerator might not operate consistently when sited for an extended period of time below the cold end of the range of temperatures for which the refrigerator appliance is designed.
- 2) The fact that effervescent drinks should not be stored in low-temperature compartments or cabinets, and that some products such as water ices should not be consumed too cold;
- 3) The need to not exceed the storage time recommended by the food manufacturers for any kind of food and particularly for commercially quick-frozen food in food-refrigerator and frozen-food storage compartments or cabinets;
- 4) The precautions necessary to prevent an undue rise in the temperature of the frozen food while defrosting the refrigerating appliance, such as wrapping the frozen food in several layers of newspaper.
- 5) The fact that a rise in temperature of the frozen food during manual defrosting, maintenance or cleaning could shorten the storage life.

## 1.7 Warnings related to disposal



The refrigerator's refrigerant and cyclopentane foam materials are combustible materials and discarded refrigerators should be isolated from fire sources and can not be burned. Please transfer the refrigerator to qualified professional recycling companies for processing to avoid damages to the environment or other hazards.



Please remove the door of the refrigerator and shelves which shall be properly placed to avoid accidents of children entering and playing in the refrigerator.



Correct Disposal of this product:

This marking indicates that this product should not be disposed with other household wastes. To prevent possible harm to the environment or human health from uncontrolled waste disposal, recycle it responsibly to promote the sustainable reuse of material resources. To return your used device, please use the return and collection systems or contact the retailer where the product was purchased. They can take this product for environmental safe recycling.

## 2 Proper use of refrigerator

### 2.1 Names of components

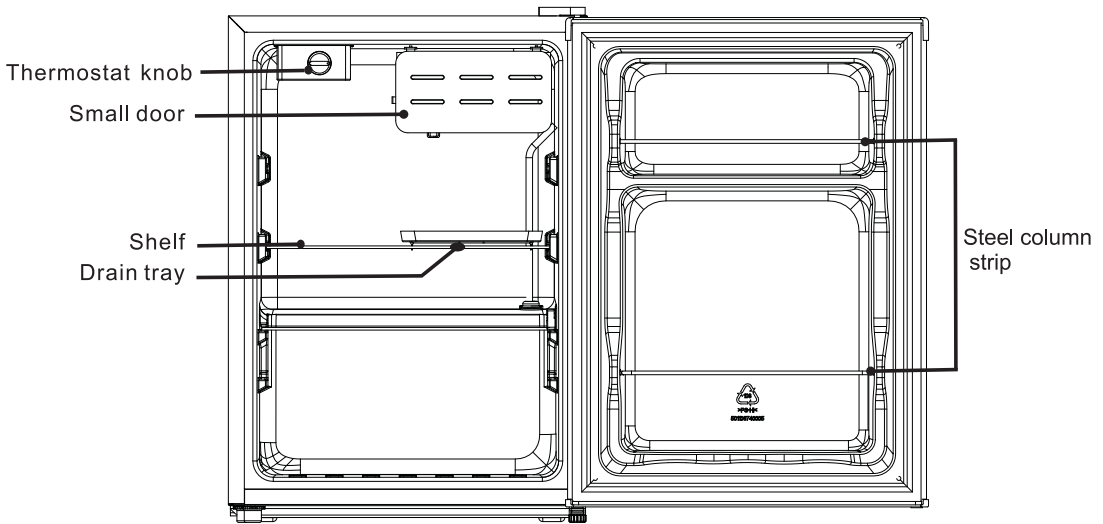

( The picture above is only for reference. The actual configuration will depend on the physical product or statement by the distributor )

### Refrigerating chamber

- The Refrigerating Chamber is suitable for storage of a variety of fruits, vegetables, beverages and other food consumed in the short term. **Suggested storage time 3days to 5days.**
- **It is the most energy efficient to place food in the position shown in the picture above.**
- Cooking foods shall not be put in the refrigerating chamber until cooled to room temperature.
- Foods are recommended to be sealed up before putting into the refrigerator.  
The glass shelves can be adjusted up or down for a reasonable amount of storage space and easy use.



## 2.2 Thermostat knob

- Setting “Off” : UnitOff  
Setting “Min” : Less Cool Temperature  
Setting “Med” : Normal Operation(adequate for most situations)  
Setting “Max” : Coolest Temperature  
During high ambient temperatures e.g. on hot summer days. It may be necessary to set the thermostat to the Coolest setting(position “Max” ).This may cause the compressor running continuously in order to maintain a low temperature in the cabinet.
- **For the first time you install your refrigerator, set the thermostat knob at “Med” .**
- Give your refrigerator time to cool down completely before adding food. It is the best to wait 24 hours before adding food. The thermostat knob controls the temperature. When the thermostat control knob is set to **OFF**, the refrigerator will not be running.  
**Recommended gear: Med-range**

( The instruction above is only for reference. The actual configuration will depend on the physical product or statement by the distributor )

## 2.3 Placement

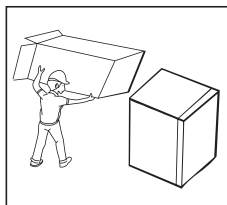

- Before using the refrigerator, remove all packaging materials including bottom cushions and foam pads and tapes inside the refrigerator , tear off the protective film on the door and the refrigerator body.

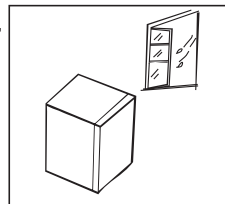

- The refrigerator should be placed in a well-ventilated indoor place; the ground shall be flat, and sturdy.

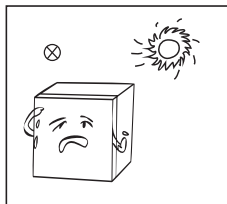

- Keep away from heat and avoid direct sunlight. Do not place the refrigerator in moist or watery places to prevent rust or reduction of insulating effect.

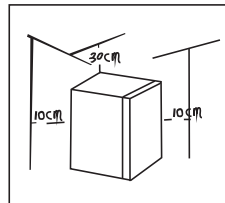

- The top space of the refrigerator shall be greater than 30cm, and the distances from both sides and backside shall be more than 10cm to facilitate heat dissipation.

## 2.4 Start to use

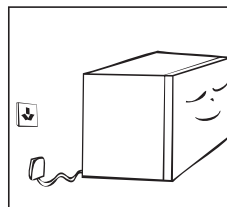



- The refrigerator shall stay for half an hour before connecting power when it is firstly started.
- The refrigerator shall run 2 to 3 hours before loading fresh or frozen foods; the refrigerator shall run for more than 4 hours in summer in advance considering that the ambient temperature is high.

## 2.5 Energy saving tips

- The appliance should be located in the coolest area of the room, away from heat producing appliances or heating ducts, and out of the direct sunlight.
- Let hot foods cool to room temperature before placing in the appliance. Overloading the appliance forces the compressor to run longer. Foods that freeze too slowly may lose quality, or spoil.
- Be sure to wrap foods properly, and wipe containers dry before placing them in the appliance. This cuts down on frost build-up inside the appliance.
- Appliance storage bin should not be lined with aluminum foil, wax paper, or paper toweling. Liners interfere with cold air circulation, making the appliance less efficient.
- Organize and label food to reduce door openings and extended searches. Remove as many items as needed at one time, and close the door as soon as possible.

## 2.6 Door right-left change

List of tools to be provided by the user	
	Cross screwdriver
	Thin-blade screwdriver
	Masking tape

1) Remove all food from door shelves. Fix the door by tapes.

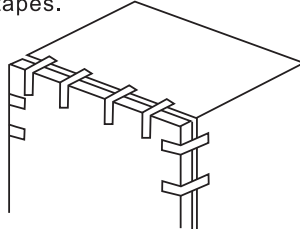

2) Dismantle hole caps, the upper hinge cover, fitting screws of upper hinge, and remove the upper hinge, please keep the door vertical in whole process for avoiding falling down;

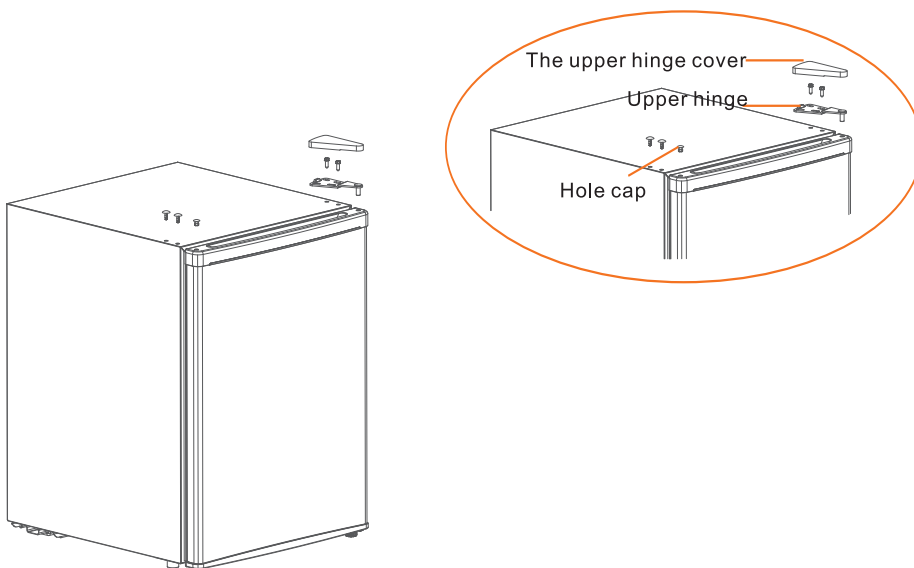

3) Remove the door;

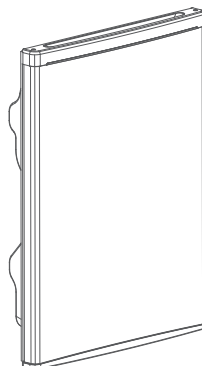

4) Dismantle the lower hinge assembly and leveling foot;

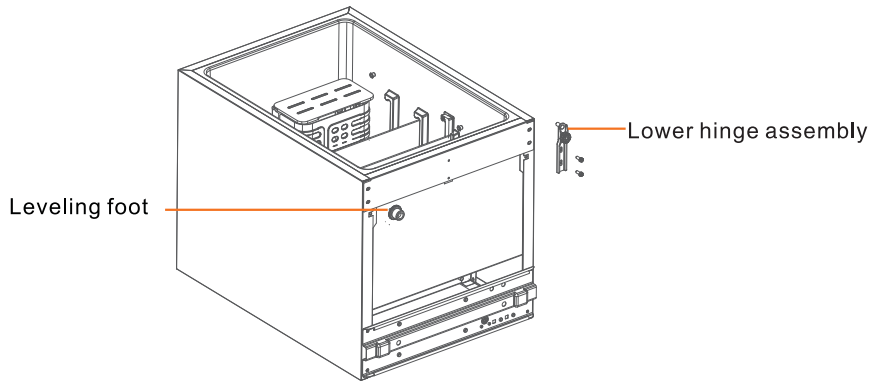

5) Install the lower hinge and leveling foot on lower left side of cabinet and lower right side respectively;

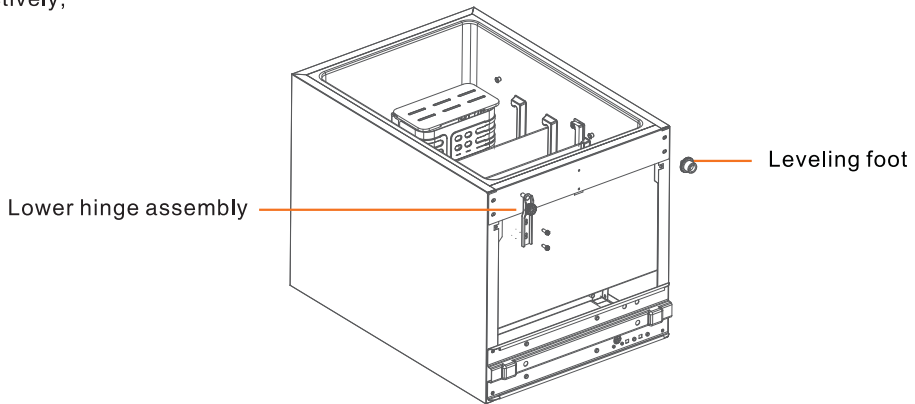

6) Put the door on lower hinge vertically, and validate the gas tightness of door gasket, then install the upper hinge by fitting screws and the hinge cover, finally cover the hole caps on upper right side.

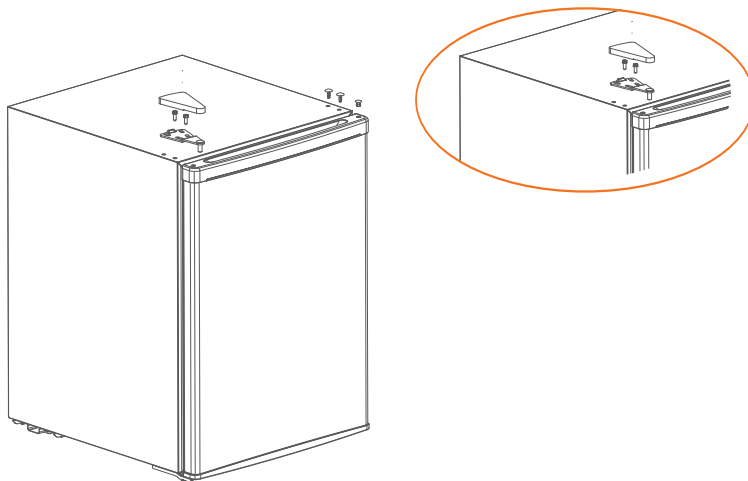

(The picture above is only for reference. The actual configuration will depend on the physical product or statement by the distributor)

## 3 Maintenance of refrigerator

### 3.1 Cleaning

- Dusts behind the refrigerator and on the ground shall be timely cleaned to improve the cooling effect and energy saving.
- Check the door gasket regularly to make sure there are no debris. Clean the door gasket with a soft cloth dampened with soapy water or diluted detergent.
- The interior of the refrigerator should be cleaned regularly to avoid odor.
- Please turn off the power before cleaning interior, remove all foods, drinks, shelves, drawers, etc.
- Use a soft cloth or sponge to clean the inside of the refrigerator, with two tablespoons of baking soda and a quart of warm water. Then rinse with water and wipe clean. After cleaning, open the door and let it dry naturally before turning on the power.
- For areas that are difficult to clean in the refrigerator (such as narrow sandwiches, gaps or corners), it is recommended to wipe them regularly with a soft rag, softbrush, etc. and when necessary, combined with some auxiliary tools (such as thin sticks) to ensure no contaminants or bacterials accumulation in these areas.
- Do not use soap, detergent, scrub powder, spray cleaner, etc., as these may cause odors in the interior of the refrigerator or contaminated food.
- Clean the bottle frame, shelves and drawers with a soft cloth dampened with soapy water or diluted detergent. Dry with a soft cloth or dry naturally.
- Wipe the outer surface of the refrigerator with a soft cloth dampened with soapy water, detergent, etc., and then wipe dry.
- Do not use hard brushes, clean steel balls, wire brushes, abrasives (such as toothpastes), organic solvents (such as alcohol, acetone, banana oil, etc.), boiling water, acid or alkaline items, which may damage the cooler surface and interior. Boiling water and organic solvents such as benzene may deform or damage plastic parts.
- Do not rinse directly with water or other liquids during cleaning to avoid short circuits or affect electrical insulation after immersion.

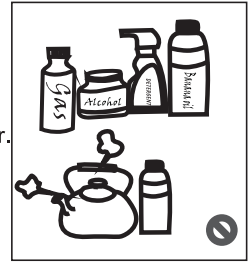

⚠ Please unplug the refrigerator for defrost and cleaning.

### 3.2 Defrost

- Refrigerator shall be manually defrosted.  
Disconnect the plug from the wall socket, open the door and remove all the food to a cool place. It is recommended to remove the frost by a plastic scraper, or let the temperature rise naturally until the frost melts. Then wipe away the remaining ice and water, and plug in socket for switching on the freezer.

Other mechanical devices or other means shall not be used to accelerate except those recommended by the manufacturer. Do not damage the refrigerant circuit.



### 3.3 Stop using

Power failure: Foods can be preserved for a couple of hours even in summer in case of power failure; it is recommended to reduce the frequency of opening door and do not put fresh foods into the refrigerator.  
Long-time nonuse: Please unplug the refrigerator left unused for a long time for cleaning.  
Keep the door open to avoid the bad odor.  
Moving: Do not turn upside or vibrate the refrigerator, the carrying angle can not be greater than 45°. Do not hold the door and hinge when moving this unit.



Continuous operation is recommended when the refrigerator is started. Please do not stop the refrigerator under normal circumstances so as not to affect the refrigerator's service life.

## 4 Trouble shooting

The following simple issues can be handled by the user. Please call the after-sale service department if the issues are not settled.

Inoperation	Whether the refrigerator is plugged and connected to power; Low voltage; Whether temperature control knob is in the work area; Failure power or tripping circuit.
Odor	Odorous foods should closely wrapped; Whether foods are rotten; Whether the interior shall be cleaned.
Long-term operation of compressor	It is normal that refrigerator operates for longer time in summer when the ambient temperature is higher; Do not put too much food in the refrigerator at one time; Do not put foods until they are cooled; Frequent opening of refrigerator door; Thick frost layer (defrost is needed).
The refrigerator door can not be properly closed	The refrigerator door is stuck by food packages; Too much food; Unbalanced refrigerator.
Loud noises	Whether the floor is flat, whether the placement of refrigerator is stable; Whether the refrigerator accessories are properly placed.
Transient difficulty in door opening	After refrigeration, there will be pressure difference between the inside and outside of the refrigerator to result in transient difficulty in door opening. This is a normal physical phenomenon.
Refrigerator enclosure heat Condensation	The refrigerator enclosure may emit heat during operation specially in summer, this is caused by the radiation of the condenser, and it is a normal phenomenon. Condensation: condensation phenomenon will be detected on the exterior surface and door seals of the refrigerator when the ambient humidity is large, this is a normal phenomenon, and the condensation can be wiped away with a dry towel.
Airflow sound Buzz Clatter	Refrigerants circulating in the refrigerant lines will produce eruption of sound and grunts which is normal does not affect the cooling effect. Buzz will be generated by running compressor specially when starting up or shutting down. The solenoid valve or electric switch valve will clatter which is a normal phenomenon and does not affect the operation.

**Table 1 Climate classes**

Class	Symbol	Ambient temperature range °C
Extended temperate	SN	+10 to +32
Temperate	N	+16 to +32
Subtropical	ST	+16 to +38
Tropical	T	+16 to +43

Extended temperate: this refrigerating appliance is intended to be used at ambient temperatures ranging from +10°C up to +32°C

Temperate: this refrigerating appliance is intended to be used at ambient temperatures ranging from +16°C up to +32°C

Subtropical: this refrigerating appliance is intended to be used at ambient temperatures ranging from +16°C up to +38°C

Tropical: this refrigerating appliance is intended to be used at ambient temperatures ranging from +16°C up to +43°C

The ordered parts in the following table can be acquired from Channel:

AMIRIDIS - SAVVIDIS S.A.  
 87A, 17th November str  
 55535, Pylea, Thessaloniki  
 Tel: +302310944944

Part description	Purchased by	Minimum availability period
thermostats	Professional maintenance personnel	At least 7 years after the last model is launched on the market
temperature sensors	Professional maintenance personnel	At least 7 years after the last model is launched on the market
printed circuit boards	Professional maintenance personnel	At least 7 years after the last model is launched on the market
light sources	Professional maintenance personnel	At least 7 years after the last model is launched on the market
door handles	Professional maintenance personnel and final users	At least 7 years after the last model is launched on the market
door hinges	Professional maintenance personnel and final users	At least 7 years after the last model is launched on the market
trays	Professional maintenance personnel and final users	At least 7 years after the last model is launched on the market
baskets	Professional maintenance personnel and final users	At least 7 years after the last model is launched on the market
door gaskets	Professional maintenance personnel and final users	At least 10 years after the last model is launched on the market

# Product Information Sheet

COMMISSION DELEGATED REGULATION (EU) 2019/2016

**Supplier's name or trademark:** MORRIS

**Supplier's address:** 17th November str 87A, 55534 Thessaloniki Pylea, Thessaloniki Thessaloniki, EL

**Model identifier:** S7368SP / W7367SP

**Type of refrigerating appliance:**

Low-noise appliance:	No	Design type:	freestanding
Wine storage appliance:	No	Other refrigerating appliance:	Yes

**General product parameters:**

Parameter		Value	Parameter	Value
Overall dimensions (millimetre)	Height	510	Total volume (l)	65
	Width	445		
	Depth	630		
EEL		125	Energy efficiency class	F
Airborne acoustical noise emissions (dB(A) re 1 pW)		41	Airborne acoustical noise emission class	C
Annual energy consumption (kWh/a)		103	Climate class:	temperate, subtropical, tropical
Minimum ambient temperature (°C), for which the refrigerating appliance is suitable		16	Maximum ambient temperature (°C), for which the refrigerating appliance is suitable	43
Winter setting		No		

**Compartment Parameters:**

Compartment type	Compartment parameters and values				
	Compartment volume (dm <sup>3</sup> or l)	Recommended temperature setting for optimised food storage (°C) These settings shall not contradict the storage conditions set out in Annex IV, Table 3	Freezing capacity (kg/24h)	Defrosting type (auto-defrost=A, manual defrost=M)	
Pantry	No	-	-	-	-
Wine storage	No	-	-	-	-
Cellar	No	-	-	-	-
Fresh food	Yes	65	4	-	M

Chill	No	-	-	-	-
0-star or ice-making	No	-	-	-	-
1-star	No	-	-	-	-
2-star	No	-	-	-	-
3-star	No	-	-	-	-
4-star	No	-	-	-	-
2-star section	No	-	-	-	-
Variable temperature compartment	-	-	-	-	-
<b>For 4-star compartments</b>					
Fast freeze facility			No		
<b>Light source parameters:</b>					
Type of light source			No light source		
Energy efficiency class			-		
<b>Minimum duration of the guarantee offered by the manufacturer:</b> 24 months					
<b>Additional information:</b>					
<b>Weblink to the manufacturer's website, where the information in point4(a) Annex of Commission Regulation (EU) 2019/2019 is found:</b> <a href="http://www.morris.gr">www.morris.gr</a>					



## **NOTICE ABOUT RECYCLING**



Your product is designed and manufactured with high quality materials and components which can be recycled and reused.

This symbol means that electrical and electronic equipment, at their end-of-life,

should be disposed of separately from your household waste.

Please dispose of this equipment at your local community waste collection/ recycling centre.

In the European Union there are separate collection systems for used electrical and electronic products.

Please help us to conserve the environment we live in!

## **DECLARATION OF CONFORMITY**

Herewith, we state that this product, complies with the requirements of below directives:

EMC-Directive: 14 / 30 / EU

Low Voltage Directive: 14/ 35 / EU

ErP Directive 09 / 125 / EC

CE Marking: 93 / 68 / EEC

RoHS Directive: 11 / 65 / EU & Delegated Directive (EU) 15 / 863

The detailed declaration of conformity can be found at [www.morris.gr](http://www.morris.gr)





**IMPORTER:**

**Kalliopi Karyda & Co, LP**  
87A, 17th November str.  
55535, Pylea, Thessaloniki  
Tel. 2316 006600  
Fax. 2316 006650  
[www.morris.gr](http://www.morris.gr)