



# MORRIS

**S7449SDL**

**W7448SDL**

## USER MANUAL

**REFRIGERATOR**

Please read this manual carefully before use this product

# CONTENTS

## 1 Safety warnings

1.1 Warning	1-2
1.2 Meanings of safety warning symbols	3
1.3 Electricity related warnings	3
1.4 Warnings for using	4
1.5 Warnings for placement	4-5
1.6 Warnings for energy	5
1.7 Warnings for disposal	5

## 2 Proper use of the refrigerator

2.1 Placement	6
2.2 Levelling feet	7
2.3 Door Right-Left Change	8
2.4 Changing the Light	9
2.5 Starting to use	9
2.6 Energy saving tips	9

## 3 Structure and functions

3.1 Key components	10
3.2 Functions	11

## 4 Maintenance and care of the refrigerator

4.1 Overall cleaning	12
4.2 Defrost	12
4.3 Stop using	12

## 5 Trouble shooting

5.1 Trouble shooting	13
----------------------	----

# 1 Safety warnings

## 1.1 Warning



**Warning**: risk of fire / flammable materials

**THIS** appliance is intended to be used in household and similar applications such as staff kitchen areas in shops, offices and other working environments; farm houses and by clients in hotels, motels and other residential type environments; bed and breakfast type environments; catering and similar non-retail applications.

**IF** the supply cord is damaged, it must be replaced by the manufacturer, its service agent or similarly qualified persons in order to avoid a hazard.

**DO** not store explosive substances such as aerosol cans with a flammable propellant in this appliance.

**THE** appliance has to be unplugged after use and before carrying out user maintenance on the appliance.

**WARNING**: Keep ventilation openings, in the appliance enclosure or in the built-in structure, clear of obstruction.

**WARNING**: Do not use mechanical devices or other means to accelerate the defrosting process, other than those recommended by the manufacturer.

**WARNING**: Do not damage the refrigerant circuit.

**WARNING**: Do not use electrical appliances inside the food storage compartments of the appliance, unless they are of the type recommended by the manufacturer.

**WARNING**: Please abandon the refrigerator according to local regulators for its use of flammable blowing gas and refrigerant.

**WARNING**: When positioning the appliance, ensure the supply cord is not trapped or damaged.

**WARNING**: Do not locate multiple portable socket-outlets or portable power supplies at the rear of the appliance.

**DO** not use extension cords or ungrounded ( two prong ) adapters.

**DANGER**: Risk of child entrapment. Before you throw away your old refrigerator or freezer:

–Take off the doors.

–Leave the shelves in place so that children may not easily climb inside.

**THE** refrigerator must be disconnected from the source of electrical supply before attempting the installation of accessory.

**REFRIGERANT** and cyclopentane foaming material used for the appliance are flammable. Therefore, when the appliance is scrapped, it shall be kept away from any fire source and be recovered by a special recovering company with corresponding qualification other than be disposed by combustion, so as to prevent damage to the environment or any other harm.

**FOR** EN standard: This appliance can be used by children aged from 8 years and above and persons with reduce physical sensory or mental capabilities or lack of experience and knowledge if they have been given supervision or instruction concerning use of the appliance in a safe way and understand the hazards involved. Children shall not play with the appliance. Cleaning and user maintenance shall not be made by children without supervision. Children aged from 3 to 8 years are allowed to load and unload refrigerating appliances.

**FOR** IEC standard: This appliance is not intended for use by persons (including children) with reduced physical, sensory or mental capabilities, or lack of experience and knowledge, unless they have been given supervision or instruction concerning use of the appliance by a person responsible for their safety.)



**CHILDREN** should be supervised to ensure that they do not play with the appliance.

**TO** avoid contamination of food , please respect the following instructions:

- Opening the door for long periods can cause a significant increase of the temperature in the compartments of the appliance.
- Clean regularly surfaces that can come in contact with food and accessible drainage systems.
- Clean water tanks if they have not been used for 48 h; flush the water system connected to a water supply if water has not been drawn for 5 days. (note 1)
- Store raw meat and fish in suitable containers in the refrigerator, so that it is not in contact with or drip onto other food.
- Two-star **☆☆** frozen-food compartments are suitable for storing pre-frozen food, storing or making ice-cream and making ice cubes. (note 2)
- One **★**-, two **☆☆** -and three-star **☆☆☆** compartments are not suitable for the freezing of fresh food. (note 3)
- If the refrigerating appliance is left empty for long periods, switch off, defrost, clean, dry, and leave the door open to prevent mould developing within the appliance.

Note 1,2,3: Please confirm whether it is applicable according to your product compartment type.

## 1.2 Meaning of safety warning symbols

	This is a prohibition symbol. Any incomppliance with instructions marked with this symbol may result in damage to the product or endanger the personal safety of the user.
	This is a warning symbol. It is required to operate in strict observance of instructions marked with this symbol; or otherwise damage to the product or personal injury may be caused.
	This is a cautioning symbol. Instructions marked with this symbol require special caution. Insufficient caution may result in slight or moderate injury, or damage to the product.

This manual contains lots of important safety information which shall be observed by the users.

## 1.3 Electricity related warnings

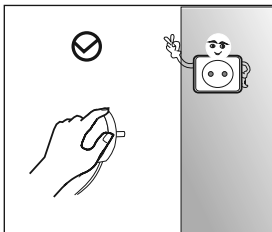

- Do not pull the power cord when pulling the power plug of the refrigerator. Please firmly grasp the plug and pull out it from the socket directly.
- To ensure safe use, do not damage the power cord or use the power cord when it is damaged or worn.

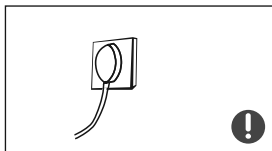

- Please use a dedicated power socket and the power socket shall not be shared with other electrical appliances. The power cord should be firmly contacted with the socket or else fires might be caused.
- Please ensure that the grounding electrode of the power socket is equipped with a reliable grounding line.

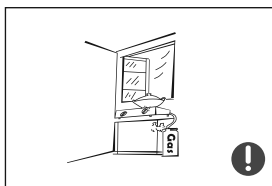

- Please turn off the valve of the leaking gas and then open the doors and windows in case of leakage of gas and other flammable gases. Do not unplug the refrigerator and other electrical appliances considering that spark may cause a fire.

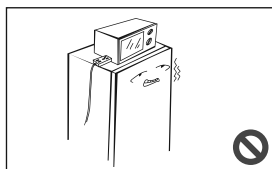

- Do not use electrical appliances on the top of the appliance, unless they are of the type recommended by the manufacturer.

## 1.4 Warnings for using

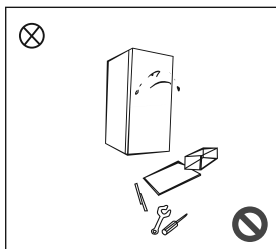

- Do not arbitrarily disassemble or reconstruct the refrigerator, nor damage the refrigerant circuit; maintenance of the appliance must be conducted by a specialist
- Damaged power cord must be replaced by the manufacturer, its maintenance department or related professionals in order to avoid danger.

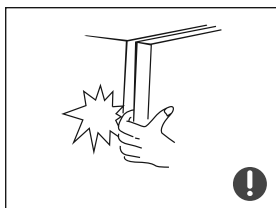

- The gaps between refrigerator door and cabinet is small, be noted not to put your hand in these areas to prevent from squeezing the finger. Please be gentle when close the refrigerator door to avoid falling articles.
- Do not pick foods or containers with wet hands in the freezing chamber when the refrigerator is running, especially metal containers in order to avoid frostbite.



- Do not allow any child to get into or climb the refrigerator; otherwise suffocation or falling injury of the child may be caused.

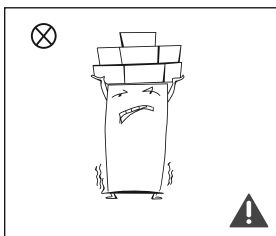

- Do not place heavy objects on the top of the refrigerator considering that objectives may fall when open or close the door, and accidental injuries might be caused.
- Please pull out plug in case of power failure or cleaning. Do not connect the freezer to power supply within five minutes to prevent damages to the compressor due to successive starts.

## 1.5 Warnings for placement

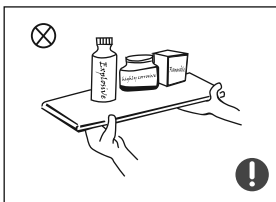

- Do not put flammable, explosive, volatile and highly corrosive items in the refrigerator to prevent damages to the product or fire accidents.
- Do not place flammable items near the refrigerator to avoid fires.

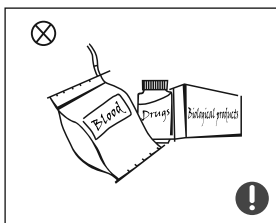

- The refrigerator is intended for household use, such as storage of foods; it shall not be used for other purposes, such as storage of blood, drugs or biological products, etc.

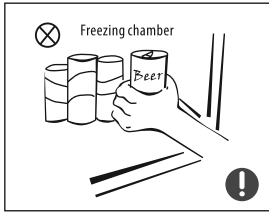

- Do not store beer, beverage or other fluid contained in bottles or enclosed containers in the freezing chamber of the refrigerator; otherwise the bottles or enclosed containers may crack due to freezing to cause damages.

## 1.6 Warnings for energy

- 1) Refrigerating appliances might not operate consistently (possibility of defrosting of contents or temperature becoming too warm in the frozen food compartment) when sited for an extended period of time below the cold end of the range of temperatures for which the refrigerating appliance is designed.
- 2) The fact that effervescent drinks should not be stored in food freezer compartments, and that some products such as water ices should not be consumed too cold;
- 3) The need to not exceed the storage time(s) recommended by the food manufacturers for any kind of food and particularly for commercially quick-frozen food in freezer ;
- 4) The precautions necessary to prevent an undue rise in the temperature of the frozen food while defrosting the refrigerating appliance, such as wrapping the frozen food in several layers of newspaper.
- 5) The fact that a rise in temperature of the frozen food during manual defrosting, maintenance or cleaning could shorten the storage life.
- 6) The necessity that, for doors or lids fitted with locks and keys, the keys be kept out of the reach of children and not in the vicinity of the refrigerating appliance, in order to prevent children from being locked inside

## 1.7 Warnings for disposal

Refrigerant and cyclopentane foaming material used for the refrigerator are flammable.



Therefore, when the refrigerator is scrapped, it shall be kept away from any fire source and be recovered by a special recovering company with corresponding qualification other than be disposed by combustion, so as to prevent damage to the environment or any other harm.



When the refrigerator is scrapped, disassemble the doors, and remove the seal of the door and shelves; put the doors and shelves in a proper place, so as to prevent trapping of any child.



Correct Disposal of this product :

This marking indicates that this product should not be disposed with other household wastes throughout the EU. To prevent possible harm to the environment or human health from uncontrolled waste disposal, recycle it responsibly to promote the sustainable reuse of material resources. To return your used device, please use the return and collection systems or contact the retailer where the product was purchased. They can take this product for environmental safe recycling.

## 2 Proper use of refrigerators

### 2.1 Placement

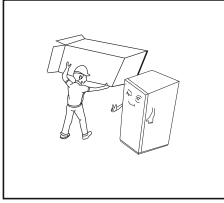

- Before use, remove all packing materials, including bottom cushions, foam pads and tapes inside of the refrigerator; tear off the protective film on the doors and the refrigerator body.

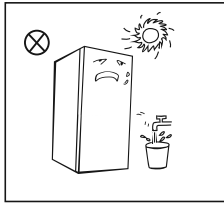

- Keep away from heat and avoid direct sunlight. Do not place the freezer in moist or watery places to prevent rust or reduction of insulating effect.
- Do not spray or wash the refrigerator; do not put the refrigerator in moist places easy to be splashed with water so as not to affect the electrical insulation properties of the refrigerator.

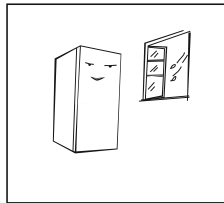

- The refrigerator is placed in a well-ventilated indoor place; the ground shall be flat, and sturdy (rotate left or right to adjust the wheel for leveling if unstable).

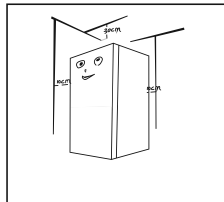

- The top space of the refrigerator shall be greater than 30cm, and The refrigerator should be placed against a wall with a free distance more than 10cm to facilitate heat dissipation.

#### ⓘ Precautions before installation:

Information in the Instruction Manual is only for reference. The physical product may differ. Before installation and adjusting of accessories, it shall be ensured that the refrigerator is disconnected from power.

Precautions shall be taken to prevent fall of the handle from causing any personal injury.



## 2.2 levelling feet

Schematic diagram of the levelling feet

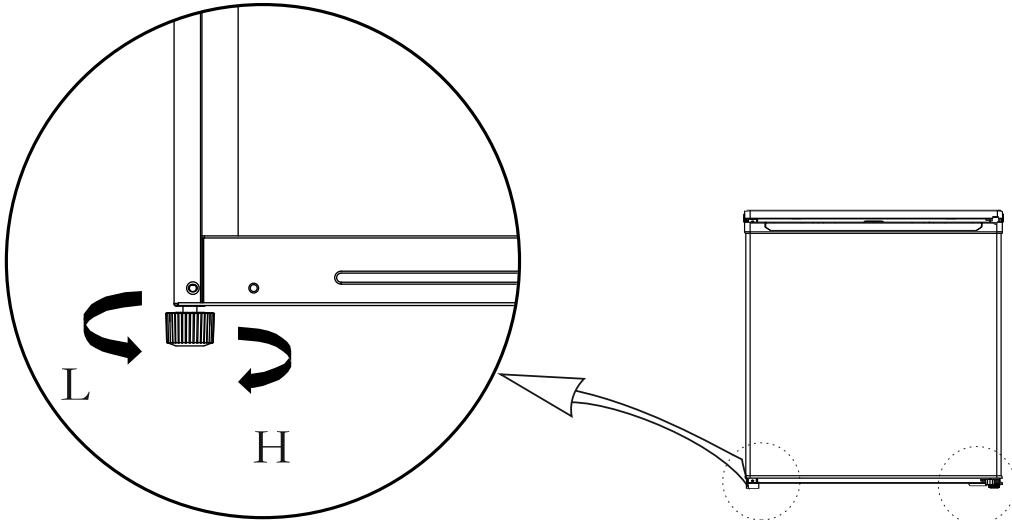





( The picture above is only for reference. The actual configuration will depend on the physical product or statement by the distributor )

Adjusting procedures:

- a. Turn the feet clockwise to raise the refrigerator;
- b. Turn the feet counterclockwise to lower the refrigerator;
- c. Adjust the right and left feet based on the procedures above to a horizontal level.

## 2.3 Door Right-Left Change

List of tools to be provided by the user			
	Cross screwdriver		Putty knife
			thin-blade screwdriver
	5/16" socket and ratchet		Masking tape

- 1) Power off the refrigerator, and remove all objects from the door trays.
- 2) Fix the door by tape.

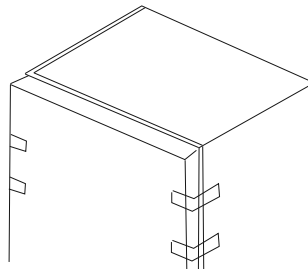

3) Remove upper hinge plastic cover

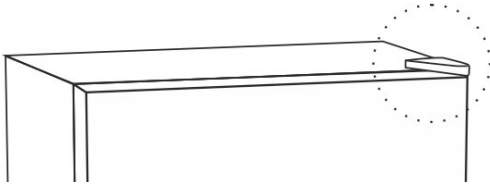

4) Unscrew screws of upper hinge .Remove the upper hinge.

5) Remove the door. Unscrew screws of bottom hinge , remove bottom hinge and levelling feet.

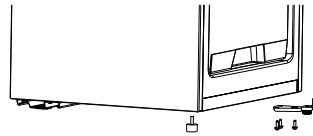
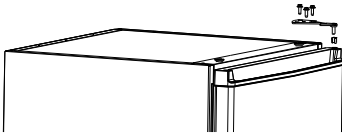

6) Fix the levelling feet, bottom hinge in the opposite side.

7) Assemble the door stopper and axle sleeve in the opposite side.

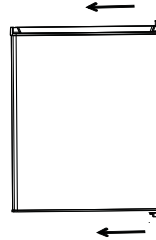
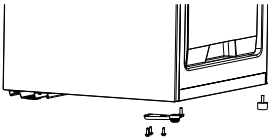

8) Put down the door on bottom hinge vertically.

Fix the upper hinge, fix hinge cover

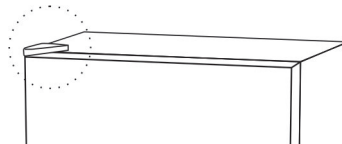
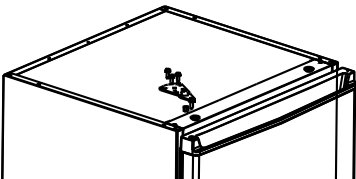

## 2.4 Changing the Light

Any replacement or maintenance of the LED lamps is intended to be made by the manufacturer, its service agent or similar qualified person.

## 2.5 Starting

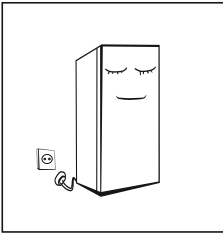

- Before initial start, keep the refrigerator still for half an hour before connecting it to power supply.
- Before putting any fresh or frozen foods, the refrigerator shall have run for 2-3 hours, or for above 4 hours in summer when the ambient temperature is high.

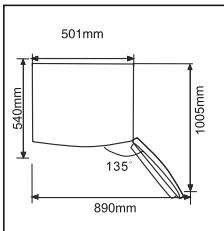

- Spare enough space for convenient opening of the doors and drawers or statement by the distributor.

## 2.6 Energy saving tips

- The appliance should be located in the coolest area of the room, away from heat producing appliances or heating ducts, and out of the direct sunlight.
- Let hot foods cool to room temperature before placing in the appliance. Overloading the appliance forces the compressor to run longer. Foods that freeze too slowly may lose quality, or spoil.
- Be sure to wrap foods properly, and wipe containers dry before placing them in the appliance. This cuts down on frost build-up inside the appliance.
- Appliance storage bin should not be lined with aluminum foil, wax paper, or paper toweling. Liners interfere with cold air circulation, making the appliance less efficient.
- Organize and label food to reduce door openings and extended searches. Remove as many items as needed at one time, and close the door as soon as possible.

## 3 Structure and functions

### 3.1 Key components

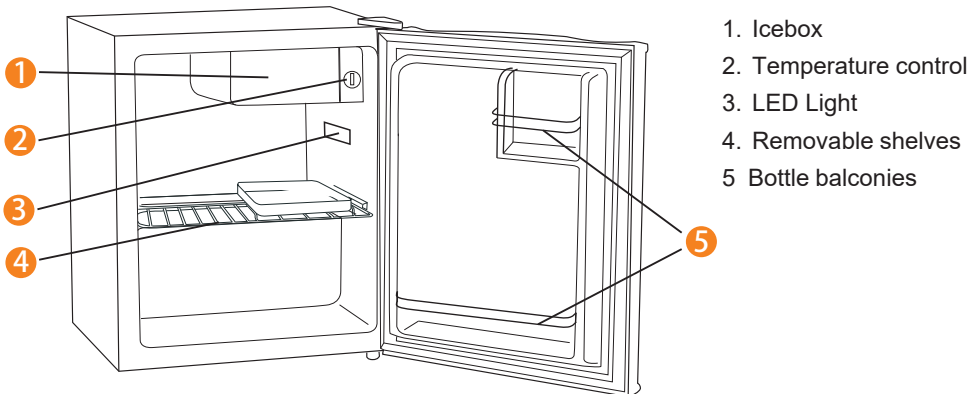

**!** ( The picture above is only for reference. The actual configuration will depend on the physical product or statement by the distributor )

#### Refrigerating chamber

- The Refrigerating Chamber is suitable for storage of a variety of fruits, vegetables, beverages and other food consumed in the short term. suggested storage time 3days to 5days.
- Cooking foods shall not be put in the refrigerating chamber until cooled to room temperature.
- Foods are recommended to be sealed up before putting into the refrigerator.
- The glass shelves can be adjusted up or down for a proper storage space and easy use.

Note: Storage of too much food during operation after the initial connection to power may adversely affect the freezing effect of the refrigerator. Foods stored shall not block the air outlet; or otherwise the freezing effect will also be adversely affected.

Drawers, food boxes, shelves, etc. placed according to the position in the picture a most energy efficient.

#### The Chiller compartment

This compartment is designed for production of ice cubes and short-term storage (3-4 days at most) of some commercially frozen foods.

The temperature in this compartment does not get cold enough to freeze food safely for long periods of time and works best when the food is already frozen.

By design, this chiller compartment is not a true freezer and may not keep ice cream frozen, or freeze items.

A colder setting may be used for these items, but other items in the refrigerator may also be affected.

The chiller door is susceptible to breaking due to excessive ice build up. This part is not covered under your warranty. Be sure to defrost when the ice reaches 6mm inch thick

## Temperature-control knob

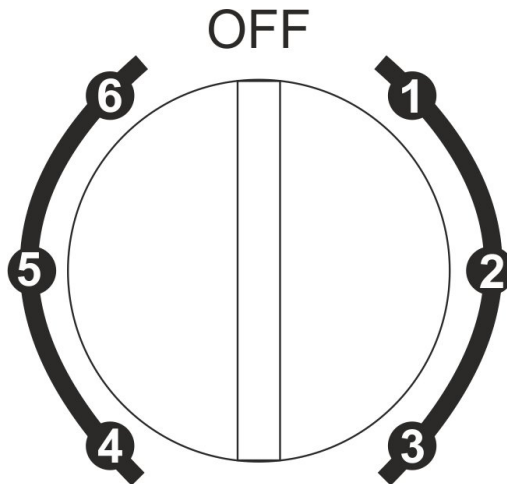

**!** ( The picture above is only for reference. The actual configuration will depend on the physical product or statement by the distributor )

### **Temperature control**

The fridge has only one control for regulating the temperature in the compartment. The temperature control is located on the upper right hand side of the compartment.

The first time you turn the unit on, set the temperature control to '6'.

The range of the temperature control is from position OFF to '6'. After 24 to 48 hours, adjust the temperature control to the setting that best suites your needs.

Recommended temperature setting is the setting of '4'

To turn the appliance off, turn the temperature control to OFF

### **NOTE**

Turning the temperature control to OFF position stops the cooling cycle but does not shut off the power to the unit.

If the unit is unplugged, has lost power, or is turned off, you must wait 3 to 5 minutes before restarting the unit. If you attempt to restart before this time delay, the unit will not start

## 4. Maintenance and care of the appliance

### 4.1 Overall cleaning

- Dusts behind the refrigerator and on the ground shall be timely cleaned to improve the cooling effect and energy saving.
- Check the door gasket regularly to make sure there are no debris. Clean the door gasket with a soft cloth dampened with soapy water or diluted detergent.
- The interior of the refrigerator should be cleaned regularly to avoid odor.
- Please turn off the power before cleaning interior, remove all foods, drinks, shelves, drawers, etc.
- Use a soft cloth or sponge to clean the inside of the refrigerator, with two tablespoons of baking soda and a quart of warm water. Then rinse with water and wipe clean. After cleaning, open the door and let it dry naturally before turning on the power.
- For areas that are difficult to clean in the refrigerator (such as narrow sandwiches, gaps or corners), it is recommended to wipe them regularly with a soft rag, softbrush, etc. and when necessary, combined with some auxiliary tools (such as thin sticks) to ensure no contaminants or bacterials accumulation in these areas.
- Do not use soap, detergent, scrub powder, spray cleaner, etc., as these may cause odors in the interior of the refrigerator or contaminated food.
- Clean the bottle frame, shelves and drawers with a soft cloth dampened with soapy water or diluted detergent. Dry with a soft cloth or dry naturally.
- Wipe the outer surface of the refrigerator with a soft cloth dampened with soapy water, detergent, etc., and then wipe dry.
- Do not use hard brushes, clean steel balls, wire brushes, abrasives (such as toothpastes), organic solvents (such as alcohol, acetone, banana oil, etc.), boiling water, acid or alkaline items, which may damage the cooler surface and interior. Boiling water and organic solvents such as benzene may deform or damage plastic parts.
- Do not rinse directly with water or other liquids during cleaning to avoid short circuits or affect electrical insulation after immersion.



⚠ Please unplug the refrigerator for defrost and cleaning.

### 4.2 Defrost

- Power off the refrigerator.
- Remove the food from the refrigerator and place it properly to prevent food from melting.
- You can use the natural temperature for the natural defrost, you can also use the ice shovel to eliminate the frost (to use plastic or wooden ice shovel, for avoiding damage to the liner or pipe)
- You can also use the appropriate amount of hot water to speed up the defrost, with a dry towel to dry the water after defrosting.
- After defrosting, put back the foods in cabinet, and power on the refrigerator.

### 4.3 Stop using

- Power failure: In case of power failure, even if it is in summer, foods inside the appliance can be kept for several hours; during the power failure, the times of door opening shall be reduced, and no more fresh food shall be put into the appliance.
- Long-time nonuse: The appliance shall be unplugged and then cleaned; then the doors are left open to prevent odor.
- Moving: Before the refrigerator is moved, take all objects inside out, fix the glass partitions, vegetable holder, freezing chamber drawers and etc. with tape, and tighten the leveling feet; close the doors and seal them with tape. During moving, the appliance shall not be laid upside down or horizontally, or be vibrated; the inclination during movement shall be no more than 45°.

⚠ The appliance shall run continuously once it is started. Generally, the operation of the appliance shall not be interrupted; or otherwise the service life may be impaired

## 5. Trouble shooting

5.1 You may try to solve the following simple problems by yourself.  
If them cannot be solved, please contact the after-sales department.

PROBLEM	POSSIBLE CAUSE
Unit does not operate.	Not plugged in. The circuit breaker tripped or blown fuse. The temperature control is set at "OFF".
Compressor turns on and off frequently.	The room temperature is hotter than normal. A large amount of food has been added to the unit. The door is open too often. The door is not closed completely. The temperature control is not set correctly. The door gasket does not seal properly. <del>The unit does not have the correct clearances.</del>
Vibrations.	Check to assure that the unit is level.
The unit seems to make too much noise. The	The rattling noise may come from the flow of the refrigerant, which is normal. As each cycle ends, you may hear gurgling sounds caused by the flow of refrigerant in your unit. Contraction and expansion of the inside walls may cause popping and crackling noises. The unit is not level.
The door will not close properly.	The unit is not level. The door is reversed and not properly installed. The gasket is dirty. The shelf or water drip tray are out of position.

**Table 1 Climate classes**

Class	Symbol	Ambient temperature range °C
Extended temperate	SN	+10 to +32
Temperate	N	+16 to +32
Subtropical	ST	+16 to +38
Tropical	T	+16 to +43

**Extended temperate:** this refrigerating appliance is intended to be used at ambient temperatures ranging from +10°C up to +32°C

**Temperate:** this refrigerating appliance is intended to be used at ambient temperatures ranging from +16°C up to +32°C

**Subtropical:** this refrigerating appliance is intended to be used at ambient temperatures ranging from +16°C up to +38°C

**Tropical:** this refrigerating appliance is intended to be used at ambient temperatures ranging from +16°C up to +43°C

The ordered parts in the following table can be acquired from Channel:

AMIRIDIS - SAVVIDIS S.A.  
87A, 17th November str  
55535, Pylea, Thessaloniki  
Tel: +302310944944

Part description	Purchased by	Minimum availability period
thermostats	Professional maintenance personnel	At least 7 years after the last model is launched on the market
temperature sensors	Professional maintenance personnel	At least 7 years after the last model is launched on the market
printed circuit boards	Professional maintenance personnel	At least 7 years after the last model is launched on the market
light sources	Professional maintenance personnel	At least 7 years after the last model is launched on the market
door handles	Professional maintenance personnel and final users	At least 7 years after the last model is launched on the market
door hinges	Professional maintenance personnel and final users	At least 7 years after the last model is launched on the market
trays	Professional maintenance personnel and final users	At least 7 years after the last model is launched on the market
baskets	Professional maintenance personnel and final users	At least 7 years after the last model is launched on the market
door gaskets	Professional maintenance personnel and final users	At least 10 years after the last model is launched on the market

Dear customer

1. If you want to return or replace the product, please contact the store where you buy.

(Remember to bring the purchase invoice)

2. If your product breaks down which needs to repair, please contact after-sales service provider.



# Product Information Sheet

COMMISSION DELEGATED REGULATION (EU) 2019/2016

**Supplier's name or trademark:** MORRIS

**Supplier's address:** 17th November str 87A, 55534 Thessaloniki Pylea, Thessaloniki Thessaloniki, EL

**Model identifier:** S7449SDL / W7448SDL

**Type of refrigerating appliance:**

Low-noise appliance:	No	Design type:	freestanding
Wine storage appliance:	No	Other refrigerating appliance:	Yes

**General product parameters:**

Parameter		Value	Parameter	Value
Overall dimensions (millimetre)	Height	495	Total volume (dm <sup>3</sup> or l)	41
	Width	450		
	Depth	450		
EEL		99	Energy efficiency class	E
Airborne acoustical noise emissions (dB(A) re 1 pW)		39	Airborne acoustical noise emission class	C
Annual energy consumption (kWh/a)		79	Climate class:	temperate, subtropical
Minimum ambient temperature (°C), for which the refrigerating appliance is suitable		16	Maximum ambient temperature (°C), for which the refrigerating appliance is suitable	38
Winter setting		No		

**Compartment Parameters:**

Compartment type	Compartment parameters and values				
	Compartment volume (dm <sup>3</sup> or l)	Recommended temperature setting for optimised food storage (°C) These settings shall not contradict the storage conditions set out in Annex IV, Table 3	Freezing capacity (kg/24h)	Defrosting type (auto-defrost=A, manual defrost=M)	
Pantry	No	-	-	-	-
Wine storage	No	-	-	-	-
Cellar	No	-	-	-	-
Fresh food	Yes	41	4	-	M

Chill	No	-	-	-	-
0-star or ice-making	No	-	-	-	-
1-star	No	-	-	-	-
2-star	No	-	-	-	-
3-star	No	-	-	-	-
4-star	No	-	-	-	-
2-star section	No	-	-	-	-
Variable temperature compartment	-	-	-	-	-
<b>For 4-star compartments</b>					
Fast freeze facility			No		
<b>Light source parameters:</b>					
Type of light source			Lighting technology used: LED		
Energy efficiency class			-		
<b>Minimum duration of the guarantee offered by the manufacturer:</b> 24 months					
<b>Additional information:</b>					
<b>Weblink to the manufacturer's website, where the information in point4(a) Annex of Commission Regulation (EU) 2019/2019 is found:</b> <a href="http://www.morris.gr">www.morris.gr</a>					

## **NOTICE ABOUT RECYCLING**



Your product is designed and manufactured with high quality materials and components which can be recycled and reused.

This symbol means that electrical and electronic equipment, at their end-of-life,

should be disposed of separately from your household waste.

Please dispose of this equipment at your local community waste collection/ recycling centre.

In the European Union there are separate collection systems for used electrical and electronic products.

Please help us to conserve the environment we live in!

## **DECLARATION OF CONFORMITY**

Herewith, we state that this product, complies with the requirements of below directives:

EMC-Directive: 14 / 30 / EU

Low Voltage Directive: 14/ 35 / EU

ErP Directive 09 / 125 / EC

CE Marking: 93 / 68 / EEC

RoHS Directive: 11 / 65 / EU delegated Directive (EU) 15/863

The detailed declaration of conformity can be found at

[www.morris.gr](http://www.morris.gr)



An abstract graphic design featuring a grid of thin gray lines on a light gray background. The lines intersect at several points, marked with small dark gray dots. The lines form a series of horizontal and vertical paths, with some paths curving at 90-degree angles. The overall composition is minimalist and geometric. A solid dark gray vertical bar is positioned on the right side of the page.

**IMPORTER:**

**Kalliopi Karida & Co LP**  
87A, 17th November str.  
55535, Pylea, Thessaloniki  
Tel. 2316 006600  
Fax. 2316 006650  
[www.morris.gr](http://www.morris.gr)