

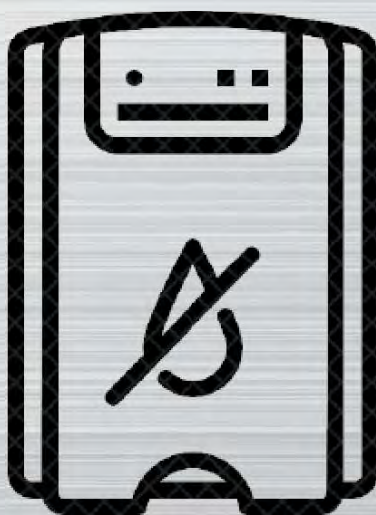

MORRIS

MDB-16160HIW
MDB-16161HIWR
MDB-16162HIWC
MDB-16163HIWB
MDB-16164HIWG

Please read this manual carefully before use this product



Dehumidifier



USER MANUAL

Contents

Safety Instructions	-----	3
Installation	-----	5
Parts	-----	6
Control Panel	-----	7
Remote Control	-----	9
Quick reference guide	-----	11
Positioning	-----	13
Water Drainage	-----	13
Care and Maintenance	-----	14
Troubleshooting	-----	16
Product Repair	-----	17
Technical Data	-----	21

Appendix

Wifi Instructions Manual



This product is using the environment friendly refrigerant R290. (ODP value is 0, GWP value is 3.3), this refrigerant is tasteless and combustibile, moreover, it can burn and explode under a certain conditions; so please read this user manual carefully before use and maintenance.

SAFETY INSTRUCTIONS

Important

- ⚠ The room area of this product should be more than 4m² when it is used, repaired and stored.
- ⚠ This product needs to be used and stored where there is no fire source (such as electric heater at work, stove with open fire, etc.)



- This product refrigerant maybe odorless.
- Do not use any method to speed up the defrosting process or clean the frosted part.
- Carefully read the instructions before operating the unit.
- This appliance is for indoor use only and intended for use in a domestic environment only. Any other use is not recommended by the manufacturer and may cause fire, electrical shocks or other injury to user or property.
- Rating: This unit must be only connected to AC 220-240V/50Hz earthed outlet.
- Installation must be in accordance with regulations of the country where the unit is used.
- If you are in any doubt about the suitability of your electrical supply have it checked and if necessary, modified by a qualified electrician.
- This dehumidifier has been tested and is safe to use. However, as with any electrical appliances-use it with care.
- Disconnect the power plug from socket before dismantling, assembling or cleaning.
- Avoid touching any moving parts of the appliance.
- Never insert fingers, pencils or any other objects though the guard.
- This appliance is not intended for use by persons (including children) with reduced physical, sensory or mental capabilities. It is also not intended for use by those with a lack of experience and knowledge, unless they have been given supervision or instruction concerning the use of the appliance by a person responsible for their safety.
- Do not leave children unsupervised with this appliance.
- Do not clean the unit by spraying it or immersing it in water.
- Never connect the unit to an electrical outlet using an extension cord. If a power outlet is not available, one should be installed by a qualified electrician.
- Never operate this appliance if the cord, power adapter or plug is damaged. Ensure the power cord is not stretched or exposed to sharp object/edges.
- A damaged power supply cord should be replaced by the manufacturer or a qualified electrician in order to avoid a hazard.
- Any service other than regular cleaning or filter replacement should be performed by an authorized service representative. Failure to comply could result in avoided warranty.
- Do not use the appliance for any other purposes than its intended use.
- Do not tilt the unit while in use. The unit is design to work only in vertical position.
- This dehumidifier must always be stored and transported upright, otherwise irreparable damage maybe caused to the compressor; if in doubt we suggest waiting at least 24 hours before starting the unit.

- Avoid restarting the dehumidifier unit unless 5 minutes have passed since being turned off. This prevents damage to the compressor.
- Never use the mains plug as a switch to start and turn off the dehumidifier. Use the provided ON/OFF switch located on the control panel.
- Always place the unit on a dry and stable surface.
- The appliance should not be installed in laundry or wet rooms where the humidity is higher than 85% RH.
- Do not dry laundry above the unit to prevent water entering the dehumidifier. Place the laundry at least 1 meter away from your dehumidifier.
- Do not place the unit next to heat sources (e.g. electrical fires, fireplaces, etc.)
- Avoid mishandling the dehumidifier. Dropping, throwing the unit can cause damage to its internals and increases the risks of operating it.
- Do not store or use gasoline, petrol, paint, solvents or other flammable vapours or liquids in the vicinity of this dehumidifier or any other appliance.
- This dehumidifier must not be used in spaces where there is a high concentration of gases, solvent or other volatile organic compounds; in very dusty environments; in any domestic, commercial or industrial environment where air composition is flammable.

Energy Saving and Unit Safety Protection Tips

- Do not cover or restrict the airflow from the outlet or inlet grills. Do not operate and follow troubleshoot procedure if the self-opening louvers do not open on power on.
- For maximum performance the minimum distance from a wall or objects should be 20 cm.
- Keep the filters or grills of the unit clean. Under normal conditions, filters or grills should only need cleaning once every three weeks (approximately).
Since the filters remove airborne particles, more frequent cleaning maybe necessary, depending on the air quality. Vacuum both mesh and optional carbon filters and wash the mesh filters with hot soapy water and dry them before placing them back in the unit.

Quick visual safety guide on where or when not to use your dehumidifier.



Exposed to the weather outdoors



Near water



If the power cable wires are frayed or cut



Where small children maybe left unattended



If an extension lead may become overloaded



Where the power cable may be damaged



On a slope or uneven surface



Where there is risk of fire or close to a naked flame



Where it may be damaged by chemicals



Where there is a risk or interference by foreign objects



This product is not made for DIY repair



If there is a risk of water falling on the unit

INSTALLATION

Remove any water from the water tank before starting the unit. In order to save energy, do not open windows or doors while the unit is running. Place the unit on a hard/flat surface. On first use run the unit continuously for 24hrs.

To reduce noise levels:

Place a piece of carpet or a rubber mat under the unit to reduce any vibrations while the unit is running.

MORRIS

dehumidifiers use compressor technology to extract water from the environment. The compressor dehumidifiers are ideal for normal domestic or office environments which are heated during the winter months with temperatures above 12-15°C.

MORRIS dehumidifiers are easy to move around on castors and intelligent dehumidifiers which will extract unwanted humidity while saving money due to their humidistat and power saving logic. MORRIS dehumidifiers feature an intelligent humidistat which is adjustable in increments of 5% from 40-80% RH insuring your room is not dried too much and power is not wasted.

Features:

Your dehumidifier belongs to the low energy premium dehumidifiers featuring low power consumption, power saving logic and advanced air purification option.

1. Easy to use controls.
2. Low energy only uses a fraction of the electricity of similar dehumidifiers.
3. Great for up to 5 bed houses.
4. Cost effective way to combat mould, condensation and damp.
5. Dries laundry more efficiently than a tumble dryer.
6. Designed to complement any modern space.
7. Castors for improved mobility.
8. Intelligent CPU controlled digital humidistat with 35-80% RH and room humidity display.
9. Quiet vs turbo fan operation ensures the right balance between quiet operation and maximum dehumidification.
10. 24 hours start/stop timer.
11. Tank operation or permanent drainage option with splash proof tank.
12. Tank full alarm&auto-stop function.

PARTS

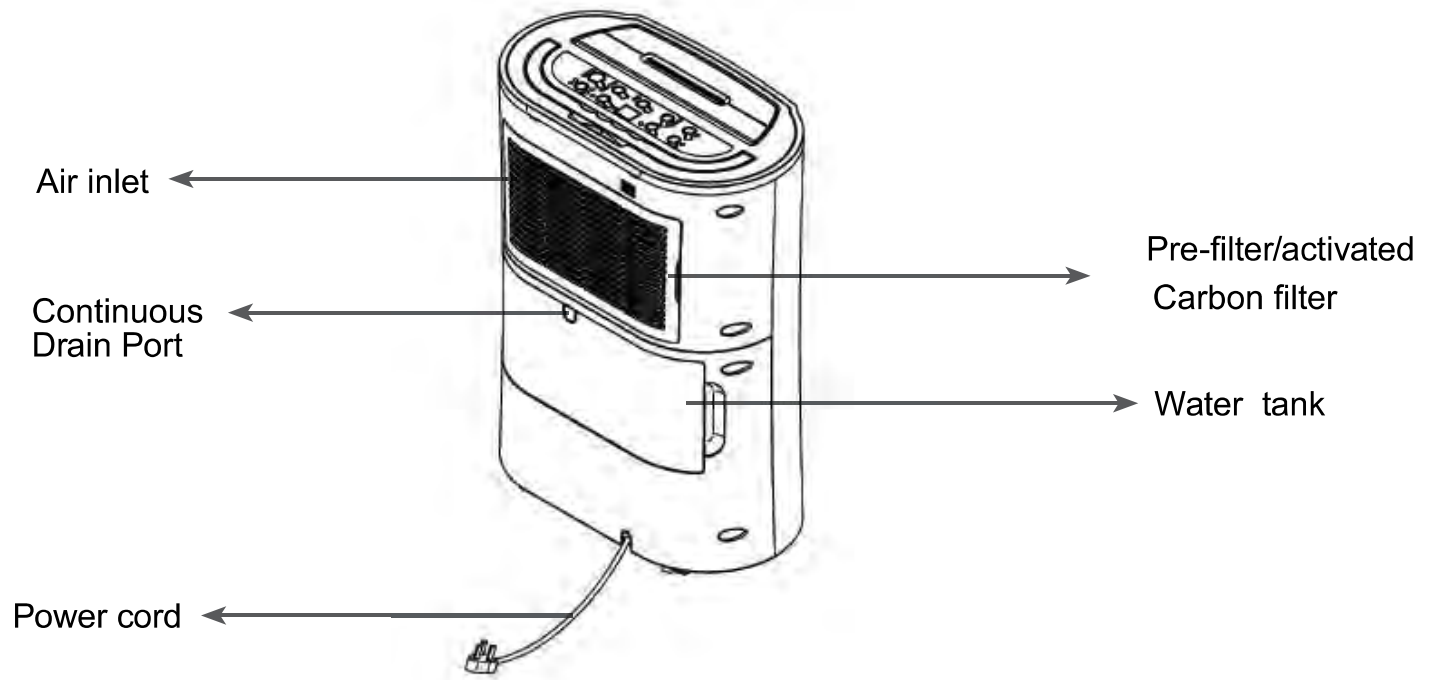
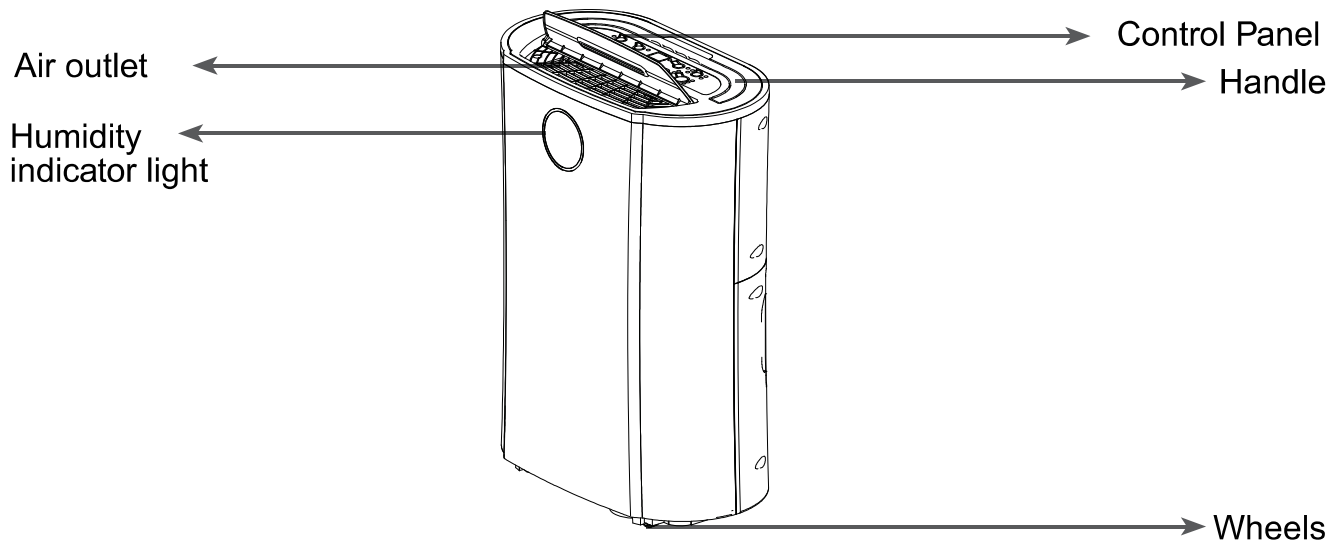



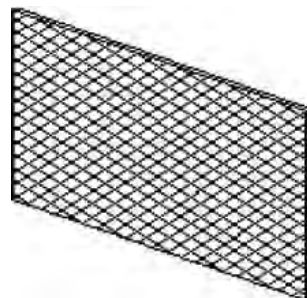

HEPA Filter



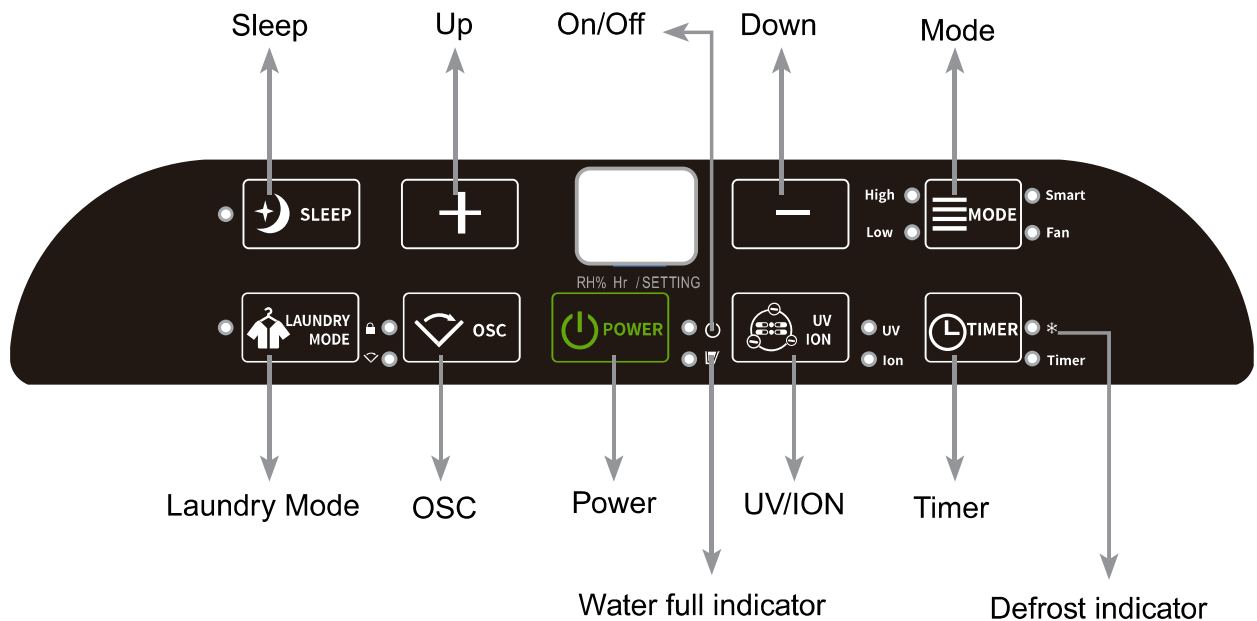





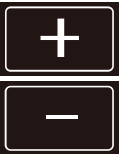

Activated carbon filter

CONTROL PANEL



	<p>POWER</p> <p>Turn on/off the appliance.</p>
	<p>MODE BUTTON</p> <p>Select the mode of the unit between :SMART/HIGH/LOW/and FAN. The unit will default to SMART mode the first time it is switched on and remains in this mode until another option is chosen.</p> <p>SMART Mode-Desired humidity set to 50-55% relative humidity and the fan is automatically adjusted depending on the current humidity level.</p> <p>HIGH/LOW Mode-Select the Fan speed, the desired humidity can then be adjusted using the Up and Down Buttons.</p> <p>FAN Mode-No moisture will be extracted in this mode, which when used with filters will purify the air. The UV and ION can also be used in this mode to further improve the quality of air emitted.</p> <p>Press "MODE" key to select "FAN", and "FAN" indicator light comes on. Only the fan will run in this mode and not water is extracted.</p> <p>Long press the button to enter the distribution network mode, and the SMART indicator flashes.</p>
	<p>SLEEP</p> <p>Press the SLEEP key to activate the SLEEP mode. The indicator light will illuminate.</p> <p>Enter the SLEEP MODE the device will work at low fan speed and low noise, The display is off and the unit makes an eco-dehumidifying.</p> <p>Press the SLEEP key again to quit the SLEEP mode, then the device will work as per the last setting before the SLEEP mode.</p> <p>If you want to turn off the humidity light on the front panel, make sure that you quit the SLEEP mode first, and then press the SLEEP key for 3 seconds, the humidity light on the front panel will be turned off. Press for another 3 seconds, the light will be turned on again.</p>

	<p>HUMIDITY SETTING</p> <p>Press UP/DOWN key to select the desired relative humidity level, default relative humidity is 55%. If relative humidity 35% is selected, the compressor will not stop until the water tank is full.</p>
	<p>TIMER (timer function)</p> <p>Press timer to program time. "TIMER" light comes on while timer is being programmed. Before programming make sure that the timer function has not been activated (the light must be off). The following timer programs are available</p> <p>a) Delayed power-on function (the appliance is in stand-by status) USE key "UP" and "DOWN" to set the time period (1~ 24 hours), the appliance will start once time reaches the set value.</p> <p>b) Delayed power-off function (whilst the appliance is running), the appliance will stop once time reaches the set value.</p>
	<p>LAUNDRY</p> <p>Press this button, the function is turned on or off, the dry mode indicator is on/off. After the function is turned on, the front panel humidity display shows 35% and the humidity is not adjustable; In this mode, the compressor does not stop and continues to run until the water tank is full or you turn off this function.</p>
	<p>OSC (Oscillating function)</p> <p>Press the "OSC" key, the louvers will swing up and down between 45° and 90°. When the key is pressed again, the louvers will remain in their current position.</p> <p><i>*Press and hold this button for 3 seconds to enter the child lock mode, the child lock indicator lights up, and other touch button touches are invalid; after pressing and holding this button for another 3 seconds, the child lock indicator light is off, and other touch button touches are effective.</i></p>
	<p>UV&ION</p> <p>UV function and ION function are controlled by one key. Press the key and select the related function, the related light will come on.</p>
	<p>INTELLIGENT DEFROST</p> <p>The appliance will defrost automatically as programmed once the coil sensor detects that temperature is too low, and the defrosting indicator will light up at the same time. Once defrosting has finished, the appliance will recover to its previous running mode.</p>
	<p>TANK-FULL</p> <p>If the water tank is full, the indicator light comes on and flashes.</p>
	<p>HEPA carbon filter (air purification function)</p> <p>Take out the filters from bag and insert them on the relative holders. It is suggested to Hoover the filters every 2-3 weeks and change them every 3-6 months to always keep the room fresh and odor free.</p>

Humidity Level & Timer 2 digit display

The led indicator performs the following functions: 1. When the unit is plugged in, it will indicate the room humidity level 2. When the humidity level is selected, it will indicate the set humidity 3. When the start/stop timer is programmed it will show the set timer.



Notes: When humidity level is outside the normal operational parameters it will show LO/HI. If ambient humidity is lower than 20%, it will show "LO". If ambient humidity is higher than 90%, it will show "HI".

REMOTE CONTROL

Press the MODE button to change Smart/high/Low/Fan/Laundry mode. Smart mode-desired humidity set to 50-55% relative humidity and the fan is automatically adjusted depending on current humidity level. The desired humidity can not be changed in this mode.

High/Low mode - Select the fan speed, the desired humidity can then be adjusted using the up and down buttons. Fan button is not adjustable, no moisture will be extracted in this mode, which when used with filters will purify the air. The UV and ION can also be used in this mode to further improve the quality of air emitted.

Laundry mode-Press laundry button, the function is turned on or off, the dry mode indicator is on/off. After the function is turned on, the front panel humidity display shows 35%, and the humidity is not adjustable in this mode. The compressor does not stop and continues to run. Until the water tank is full or you turn off this function.

In case you wish to turn off the front panel display you can keep the SLEEP button pressed for 3". In case you want to turn it back on, you can keep it again pressed for another 3".

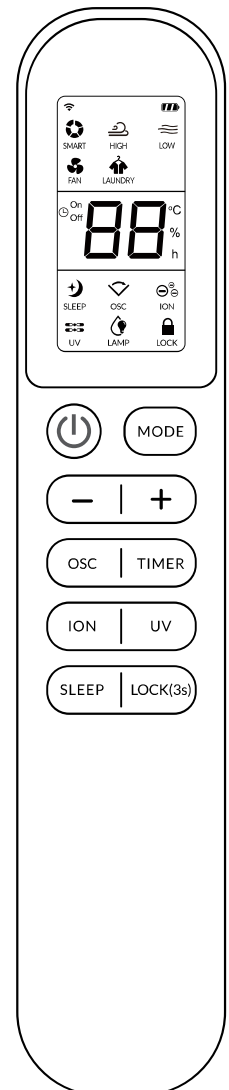

Press the timer button when the unit is in operation, to turn on/off the display of "clock+OFF" icon, it will flash 5", then press up/down button to adjust the 1-24h after which you want the unit to shut down. Press the timer button when the unit is in standby, to turn on/off the display of "clock+ON" icon, it will flash 5 seconds, then press up/down button to adjust the 1-24h and select the time to turn on.

Press the SLEEP key to activate the SLEEP mode. The indicator light will illuminate. Enter the SLEEP MODE the device will work at low fan speed and low noise, display is off. Make an eco-dehumidifying. Press the SLEEP key again to quit the SLEEP mode, then the device will work as per the last setting before the SLEEP mode.

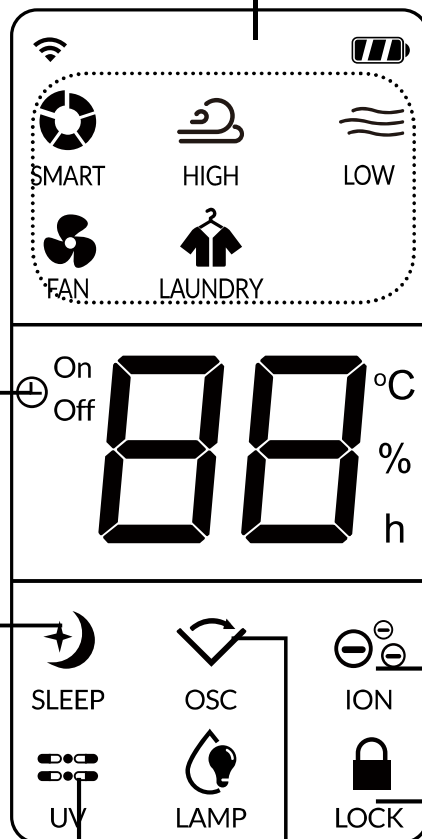

Press the UV button to turn on/off

Press the OSC button to on/off

Press the ION button to turn on/off



Turn on/off the child lock by pressing lock button within 3 seconds.



"i-Feel" Mode - The dehumidifier will work from the humidity reading taken by the remote, rather than from the dehumidifier itself. To do this, the remote sends a humidity reading to the dehumidifier each hour, which is then compared against the current setting, to decide whether the dehumidifier should be operating. To activate this mode press the up and down arrows on the remote at the same time, the icon “  ” will flash to show the mode is running.

Please note: When i-Feel is on, the head of the remote control should be pointed towards the dehumidifier and should be usually on more than 3 meters away from it (e.g. you have a damp spot in the house and you want to monitor the humidity in that spot or next to a child bed instead) . The i-Feel mode will fail if the remote is not positioned correctly towards the dehumidifier. Before activating i-Feel mode please ensure that you can operate the unit via remote control from where the remote is placed. Low battery will also affect the i-Feel mode.

QUICK REFERENCE GUIDE

Power Key  **Press to turn the dehumidifier on and off.**

Timer: Select timer settings key  then use   keys to adjust the timer(1-24hrs,start/stopping timer) . In power on mode the set number will represent the number of hours the unit will run for before turning off. This will remain unaffected if the unit goes into defrost mode or the tank is emptied and then reinserted. In standby mode the set number represents the period in hours after which the unit will start. To cancel start/stop mode press the timer key again.

Humidity Buttons: Press the Up  or Down  buttons when the unit is displaying the current relative humidity to select the desired humidity level. The humidity level can be set between a range of 35% RH(Relative Humidity) to 80% RH in 5% increments.

SMART Mode: This is designed for maximum convenience as it maintains the room at an ideal domestic environment humidity level of 50-55% RH while saving electricity. This is the default mode and is recommended for most users. The compressor will work until the desired humidity is reached and then will stop.

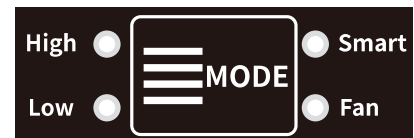

Low Fan Mode: The fan will move the air around the room ensuring the entire air in the room is processed and the relative humidity correctly measured. This mode gives you the ability to adjust the desired humidity,while running the fan at a lower speed.

High Fan Mode: The fan will move the air around the room ensuring the entire air in the room is processed and the relative humidity correctly measured. This mode gives you the ability to adjust the desired humidity,while running the fan at the high speed, allowing more air to pass over the coils than in low fan speed.

When the humidity setting is finished,the appliance will operate according to the target setting humidity. When it reaches the target humidity(the selected humidity is 2% lower than the user selected humidistat setting) , the compressor stops running , the fan continues running for five minutes and then stops , and the swing will be shut down,but the display retains. The unit shall keep this status for 30 minutes, then the swing and the fan open,and the fan starts running to test the current humidity.If it has reached the setting value,the compressor starts running. If the current humidity has not reached the setting value,the fan will be stopped after 5 minutes, swing shuts down and shall again keep this status for 30 minutes,to make another cycle as listed above. For dryer air/laundry mode press the key and set to a lower percent value (e.g. 35-45%).

Laundry Mode: For the dehumidifier to operate continuously with maximum water extraction until the tank is full set the humidity level to 35%-50% RH. 35% is very dry and the unit will work until water tank is full as 35% RH is hardly achievable in a domestic environment. Set the fan to high on laundry mode and the louvres either to swing mode or to 45 degrees directing the airflow on to clothes/laundry dryer. Do not place clothes directly over any of the dehumidifier vents. Make sure that there is nothing blocking the hot air exhaust.

airflow and for best results place the laundry within 1.5 meters of the dehumidifier.

Note: In the HIGH/LOW mode, though, if keys set humidity at 35%, and the machine is running clothes drying mode, and it will continue dehumidifying, even if the ambient humidity is less than 35%, and the compressor will not shut down. This mode applies to drying clothes and other occasions that if permanent drainage pipe is fitted the unit will not stop operation. Humidity set to achieve room humidity of around 35%, good for quick drying boost on initial run or emergencies, laundry mode. Not recommended for long normal operation in domestic/office environment. For allowing more moisture in the air, press the humidity control key and set to a higher percent value (e.g. 60-70%).

Humidity set to 50-55% RH; recommended setting, great for domestic operation and dry storage.

Humidity set to 60% RH; great for personal comfort and applications where 50% RH is considered too dry

Humidity set to 70% RH; ideal for unoccupied properties or where economical run is needed without the need to go drier than 70% RH.

Other features and Indicators

Tank Full Light

The light will be on and the unit will beep when the tank is ready to be emptied, or when the tank is removed or not placed in the proper position. The water level control switch shuts off the dehumidifier when the tank is full, or when the tank is removed or not placed in the proper position. Empty and replace to resume operation.

Auto Defrost

The appliance will defrost automatically as programmed once the coil sensor detects that the temperature is too low, and the defrosting indicator will light up at the same time. Once defrosting has finished, the appliance will recover to the previous running mode.

Humidistat control and fan/compressor operation

When the selected humidity is 2% lower than the user selected humidistat setting; the dehumidifier's compressor will be shut off automatically.

When the humidity is equal or higher than user selected humidity the compressor will restart once the 3 minutes delay compressor protection expires.

Auto-Restart

If the unit stops off unexpectedly due to the power cut, it will restart with the previous function selected automatically when the power resumes.

Power

After the unit has stopped, it is not recommended to resume operation for at least 10 minutes. This is to protect the compressor. Operation can resume after this period lapses. When the unit is restarted there is a 3 minutes delay before the compressor will start.

Lightweight Portable Design on castors

The dehumidifier is built to be compact and lightweight. The castors on the bottom of the unit make it easy to move from room to room.

Your MORRIS dehumidifier is an advanced micro-CPU controlled device able of self-diagnostics. The LCD display may also show the error and protections codes.

Positioning the dehumidifier

A badly positioned dehumidifier will have little effect. In positioning the dehumidifier please ensure circulation of air is not restricted around the unit.

Allow at least 20cm space around the unit.

This dehumidifier is designed only for indoor residential/small office applications and any commercial or industrial use will invalidate the warranty.

Use in an enclosed area for maximum efficiency.

Close all doors, windows to create an effective operating environment. Do not use outdoors.

Your the dehumidifier will begin to protect your space from the harmful effects of excessive moisture as soon as it is turned on. Excess moisture is dispersed throughout your home.

For this reason, the dehumidifier should be positioned in a central and clear location so that it can draw this moist air towards it from all over the home. A warm hallway or landing is an excellent position for your dehumidifier. If possible, leave interior doors ajar to allow air circulation.

Alternatively, if you have a serious problem in one area you can begin by positioning the dehumidifier there and moving it to a more central location at a later date. For the most effective use, run your dehumidifier with external doors and windows kept closed. Please note the unit should not be placed directly against a radiator or other heat source.

When positioning your the dehumidifier, ensure that it is placed clear of any obstacle that may limit the air movement. Place the dehumidifier on a flat dry surface.

Note: Do not force castors to move over carpet or uneven surfaces, nor move the unit with water in the tank as it may tip over and spill water.

Water Drainage

When the water tank is full, the unit will stop automatically. When this happens the tank full red light will show on the control panel.

Note: Only empty the water tank when is full or before moving or storing the unit.

There are two ways to dispense collected water.

1. Use the tank.

- When the tank is full the unit will automatically stop running, and the Full indicator light will flash.
- Slowly pull out the tank. Grip tank by its handle securely, and carefully pullout. Empty the water tank and reinsert it into the dehumidifier. The tank must be in place and securely seated for the dehumidifier to operate again.
- The dehumidifier will re-start when the tank is restored in its correct position.

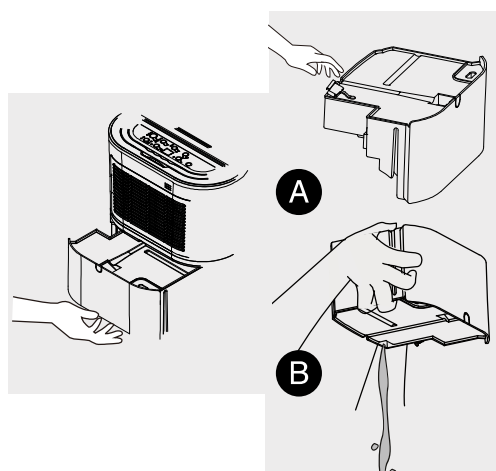
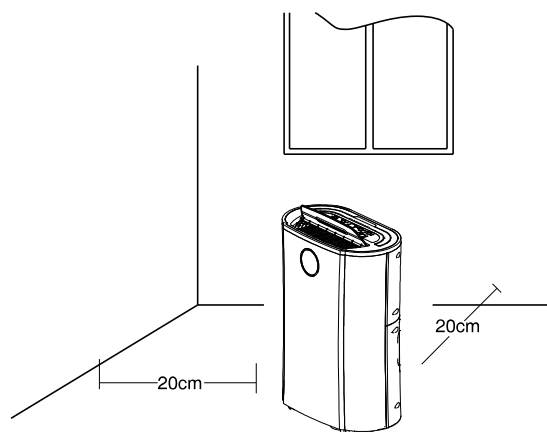

NOTES:

When you remove the bucket, do not touch sensors or any parts which are situated behind tank. Doing so may damage the product. Be sure to push the tank gently all the way into the unit. Banging the bucket against anything or failing to push it in securely into place may cause the unit not to operate.

Do not remove any parts from the water tank or tank enclosure. The water full sensor will no longer be able to detect the water level correctly and water may leak from the water tank.

2. Continuous draining

Water can be automatically plumbed in or drained into a sink, a larger recipient or through the wall into an outside drain by attaching a pipe to the unit (10mm internal diameter) (included). Insert the pipe into the drain outlet at the back of the unit as shown here.

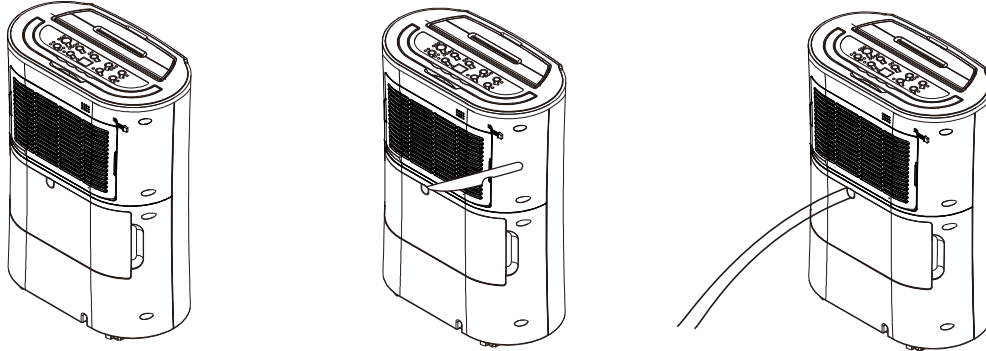

Make sure the connection between pipe and the drain outlet is tight and does not leak. Then direct the pipe to a suitable drainage point. This unit uses gravity fall to dispose water hence the drain should be lower than the unit water outlet. Put the tank back. Be sure to run the water pipe downward and let the water to flow out smoothly. Do not kink or bend the pipe.

NOTE: When the continuous drain feature is not being used, remove the drain hose from the outlet.

The permanent drain can be used in conjunction with water pump (e.g. when draining a cellar) to lift the water upwards.

Care and Maintenance

Always shut off the unit and unplug from the mains before cleaning or performing any maintenance. When it is not in use for long periods it is advisable to remove the plug from the power socket. Do not use chemical solvents (such as benzene, alcohol or gasoline) as they may cause irreversible damage to the unit.

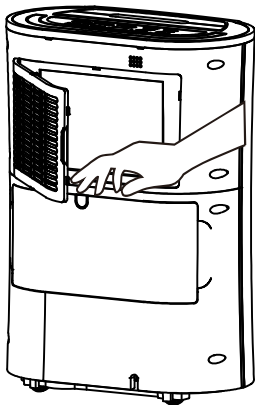

1. Clean the Grille and Case

Use water and a mild detergent to clean the washable mesh filters. Do not use bleach or abrasives. Do not splash water directly on to the main unit. Doing so may cause an electrical shock and can lead to the insulation to deteriorate, or cause the unit to rust. The air intake and

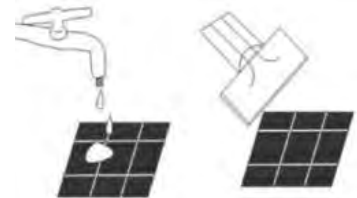

outlet grilles get soiled easily, so use a vacuum attachment or soft brush to clean. Wipe the dehumidifier body with a soft damp cloth or kitchen towel.

Remove the ABS frame and pull out the filters from the frame. Hoover gently the carbon filter once every 2-3 weeks approximately.

If the mesh filter is dirty hoover it, if it is heavily soiled wash it with warm soapy water and dry thoroughly before reinserting it in the unit.

When filter cleaning is finished and filters are dry placed them back into the filter frame and reassemble the unit.

NOTE: While the carbon filter is optional never run the unit without the mesh filter frame being assembled back.

2.Clean the water tank

Every few weeks, clean the tank to prevent growth of mould, mildew and bacteria. Partially fill the tank with clean water and add a little mild detergent. Swish it around and then empty the tank and rinse.

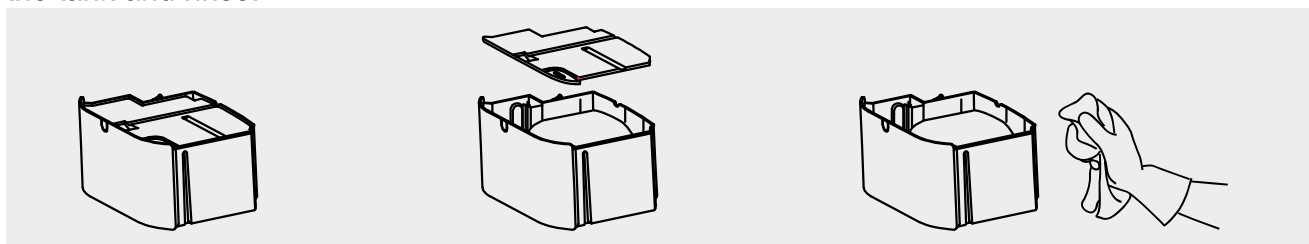

NOTE: Do not use a dishwasher to clean the tank. After cleaning and drying the tank must be reinserted securely into dehumidifier in order to restart operation.

End of Season Maintenance:

1. Empty and clean the water tank.
2. Clean the unit and the filters as per cleaning procedure above.
3. Coil the power cord on the special cord storage rest at the back of the unit.
4. Cover the unit and keep it in a dry place.

Frequently Asked Questions

Why doesn't the dehumidifier seem to extract much water if the temperature is low?

This is a compressor dehumidifier which works best in temperatures above 15°C. If the temperature is low and the air is dryer than the setting on the humidistat the unit will not extract water. If you want to use a dehumidifier for outside buildings, unheated properties, boats or garages please check our desiccant range.

Why doesn't the unit work/ or stops suddenly?

The water tank maybe full or displaced. To rectify: empty the tank and carefully place the tank back in the unit. Also the unit maybe running in dehumidifying mode with a low room temperature. Please check if the room temperature is lower than 5°C. If so, the unit will stop working while in dehumidifying mode. (unit maybe defrosting) .

The ambient operating range is between 5°C and 35°C with a relative humidity ranging from 30% to 80%. For maximum efficiency use the unit between 15°C and 32°C.

Sometimes cold and/or hot air comes out from the air outlet grill why?

When the unit is in dehumidifying mode it absorbs humid air from room and freezes it to reduce the humidity.

During the cold cycle there should be cold air coming out of the unit.

During the hot cycle hot dry air should be coming out of the outlet grill.

Troubleshooting

Issue	Cause	Solution
Hot or cold air being produced	Normal Operation	When the unit is in dehumidifying mode it absorbs humid air from room and freezes it to reduce the humidity. During the cold cycle there should be cold air coming out of the unit. During the defrost cycle hot dry air should be coming out of the outlet grill.
Unit does not operate	Is the plug properly inserted in the socket ?	Insert the plug into the socket and turn the switch on.
	Does the tank full indicator is red?	Tank full, float displaced or tank not properly inserted. Empty tank, check float and make sure tank is properly inserted in unit.
Front louvres do not open	Louvre motor is blocked	Check if anything is blocking the louvre. Try to move gently the louvres up and down while the unit is off. If the above fails return the unit to service centre.
Dehumidifier does not extract water	Is the unit set to a humidity level lower than the one in the room?	Set the humidity level on the humidistat below current humidity reading.
	Is the temperature too low for water extraction to be efficient?	Increase temperature in the room or reposition the unit.
	Is any intake grill or discharge blocked? Is the unit too close to walls.	Remove obstructions and restart the unit. Ensure a distance of at least 20cm between the unit & walls.
Airflow seems weak	Is filter dirty or clogged?	Please service the filters regularly as per user manual.
Unit is noisy during operation	Is the unit on uneven surface?	Please place on flat horizontal surface.
	Is filter clogged?	Please service the filters regularly as per user manual.
E3 or E4	Humidity sensor error	Use the unit within the prescribed humidity range. Unplug the unit, rest and plug it back in. If error repeats, call for service centre.
E1 or E2	Temperature sensor error	Use the unit within the prescribed temperature range. Unplug the unit, rest and plug it back in. If error repeats, call for service centre.
E5 or E6	Abnormal Coil sensor Temperature or current	Use the unit within the prescribed humidity and temperature range. Unplug the unit, rest and plug it back in. If error repeats, call for service centre.
Defrost light on and unit stops regularly	Unit is defrosting	Allow the unit to automatically defrost. The protection will clear after the unit self defrosts. Increase temperature in the room if this repeats too often.
Tank full red light	Water tank full notification	Tank is full or is not in the right position--Empty the tank and replace in the right position.
Any other malfunctions will need to be reported to the service centre. Do not attempt unauthorised repairs as these may invalidate the warranty.		

PRODUCT REPAIR

Warning: The appliance should be stored in a well-ventilated room. The area of the room should be equal to the room area required for maintenance.

--Warning: Appliances should be stored in rooms where there is no continuous burning fire (such as ignited gas appliances) and ignition sources (such as electric heaters at work)

---All operators or refrigeration circuit maintenance personnel should obtain a valid certificate issued by an industry-approved assessment agency to determine their qualification for safe disposal of refrigerants as required by the industry-approved assessment specification.

---The maintenance and repair of the equipment can only be carried out according to the method recommended by the equipment manufacturer. If other professionals are required to assist in the maintenance and repair of the equipment, they should be supervised by personnel qualified to use flammable refrigerants.

A.1. Inspection of the site

Prior to servicing with flammable refrigerants, a safety inspection must be performed to ensure that the risk of fire is minimized. When servicing the refrigeration system, the following precautions should be observed before handling the system.

A.2. Operating procedure

Work should be performed under controlled procedures to ensure that the risk caused by combustible gases or vapors during operations is lowest.

A.3. General working area

All maintenance personnel and other personnel in the work area should be aware of the nature of the work being performed and should work within a confined space that should be avoided. The work area should be properly segregated to ensure the safety of working conditions in the work area by controlling combustible materials.

A.4. Check if the refrigerant is present

Pre-operation and during operation should be monitored in the area using an appropriate refrigerant monitor to ensure that the technicians are aware of the presence of potentially flammable gases and that all leak detection equipment is suitable for flammable refrigerants, such as: no spark, fully enclosed or intrinsically safe.

A.5. Fire extinguisher placement

When performing heat-processing operations on the refrigeration system or related components, the appropriate fire extinguisher should be located nearby and the refrigerant injection area should be equipped with a dry powder or carbon dioxide fire extinguisher.

A.6. Prohibition of fire

When working in connection with exposed pipelines that contain or have contained flammable refrigerants, all forms of ignition sources that may cause fire or danger to the station should not be used. All sources of ignition, including smoking, are combustible. The agent may be released into the surrounding environment. It must be far away from the area where it is installed, repaired, relocated or disposed. Before starting work, the surrounding environment of the equipment must be inspected strictly to ensure that there is no danger of flammability or fire, should set up the mark of "No Smoking".

A.7. Ventilated area

Ensure that the work area is open or fully ventilated before opening the system or performing hot work operations. Ventilation should be maintained during operation. Ventilation will safely dilute the leaked refrigerant and quickly release it into the atmosphere.

A.8. Inspection of refrigeration equipment

If you replace electrical components, these electrical components should be installed in accordance with the day-to-day and night-time operating regulations. At all times, the manufacturer's maintenance and repair guides should be followed. If in doubt, consult the manufacturer's technical department.

The following inspection items apply to the installation of flammable refrigerant appliances :

- The charge should be determined according to the size of the room containing the refrigerant containing components ;
- Ventilation equipment should operate normally and vents should be free from obstructions ;
- If an inter-refrigeration refrigeration cycle is used, check the presence of refrigerant in the secondary circuit ;
- The logo on the appliance should be clearly visible. Marks and symbols that are indelible ;
- Refrigerating lines or electrical components should not be installed in environments that contain possible housing contact elements, unless the electrical components are made of corrosion-resistant materials or suitable corrosion protection measures are taken.

A.9. Inspection of Electrical Installations

The repair and maintenance of electrical components should include initial safety inspections and component inspection procedures. If there is a defect that compromises safety, the appliance power supply must be de-energized until the defect is properly disposed of. If the defect can not be completely eliminated in the end, and must continue to operate, then appropriate temporary solutions should be taken, report the situation to the owner of the appliance, and warn all relevant personnel.

The initial security check should include :

- Capacitor discharge should be performed in a safe manner to avoid sparks.
- No exposed electrical components and wiring during filling, recycling and cleaning of the system.
- Continuity of grounding.

B. Maintenance of sealing elements

B. 1 When repairing close components, disconnect the power supply of the device before opening the sealed cover. If there is power supply during the maintenance process, uninterrupted leak detection should be performed on the most dangerous parts to prevent potential dangerous situations from occurring.

B.2 In the following maintenance of electrical components, special care shall be taken not to cause maintenance methods affecting the degree of protection of the enclosure. Improper maintenance may result in damage to the cables, excessive connection, improper installation of the terminals, damage to the seals and sealing. Cover installation error and other hazards Ensure the installation of the equipment is safe and reliable.

Ensure that the sealing or sealing material does not lose its effect of preventing the entry of flammable gases due to aging, and the replacement parts should comply with the manufacturer's specifications.

Note: The use of silicon-containing sealants may reduce the detection capabilities of leak detection equipment, intrinsically safe components do not have to be isolated before operation.

C. Intrinsically safe component maintenance

If it can not be ensured that the appliance does not exceed the limits of the allowable voltage and current during use, no permanent inductance or capacitive load must be used in the circuit. The essential Ankh-type element is the only element that can continue to operate within the flammable gas. The test instrument should be set in the correct gear.

If the replacement component can only use components specified by the manufacturer, other components may cause the refrigerant that is leaking in the air to catch fire.

D. Cable

Check the cable for wear, corrosion, overpressure, vibration, sharp edges or other adverse environmental effects. This inspection should also consider the impact of aging or the continuous vibration of the compressor and fan on the cable manufacturing.

E. Inspection of flammable refrigerants

Inspection refrigerant leakage should be done in an environment where there is no potential source of ignition and should not be detected using a halogen probe (or any other detector using an open flame).

F. Leak detection method

For systems containing flammable refrigerants, the following methods for detecting leaks are acceptable:

Electronic leak detectors can be used for the detection of flammable refrigerants, but the sensitivity may not be sufficient or may require recalibration (the instrument calibration should be performed in a refrigerant-free environment) to ensure that the leak detector does not become a potential ignition source, and applies to the measured refrigerant, the leak detector should be set to the lowest flammable concentration of the refrigerant (in percent), calibrated with the used refrigerant and adjusted to the appropriate gas concentration test range (max.25%).

The leak detection fluid is suitable for most refrigerants, but do not use oxygenated solvents to prevent oxygen and refrigerant from reacting and corroding the copper pipeline.

If leakage is suspected, all open flames should be removed from the site or extinguished.

If a leak occurs where welding is required, all refrigerant should be recovered, or the refrigerant should be completely isolated away from the leak (using shut-off valves). Before welding and during welding, use oxygen-free. Nitrogen (OFN) purifies the entire system.

G. Remove and vacuum

When performing maintenance or other operations on the refrigeration circuit, routine procedures should be followed, but the flammability of the refrigerant should also be considered. Follow these procedures:

- Clear refrigerant
- Purge the line with inert gas
- Vacuum
- Purge the pipe again with inert gas
- Cutting pipelines or welding

Refrigerant should be recycled to a suitable storage tank. The system should be purged with oxygen-free nitrogen to ensure safety. This process may need to be repeated several times. This operation must not be performed with compressed air or oxygen.

In the purging process, the system is filled with oxygen-free nitrogen to reach the working pressure under the vacuum state, and then the oxygen-free nitrogen is discharged to the atmosphere. Finally, the system is evacuated to a vacuum, and the process is repeated until the refrigerant in the system is completely removed. After the last charge of anaerobic nitrogen, the gas is released to atmospheric pressure and the system can then be welded. Such as pipe welding operations, the above operation is very necessary.

Make sure there are no ignition sources near the outlet of the vacuum pump and that it is well ventilated.

H. Charge the refrigerant program

As a supplement to regular procedures, add the following requirements:

- Ensure that when using the refrigerant charging equipment, no inter-contamination between different refrigerants will occur, and the piping for charging the refrigerant should be as short as possible to reduce the residual amount of refrigerant therein.
- Tanks should be kept vertically upward
- Ensure that the cooling system has been grounded before filling the refrigerant
- Label the system after filling (or when it has not been completed)
- Must pay attention not to overcharge

The pressure test was performed with oxygen-free nitrogen before recharging the system.

After the filling was completed, a leak test was performed before the test operation. A leak test should be conducted when leaving the area.

I. Retired

Before proceeding with this procedure, technicians should be fully familiar with the equipment and all its features and recommend the practice of safe recovery of refrigerants. To recycle the recovered refrigerant, analyze the refrigerant and oil samples before performing the work.

Before testing, ensure that you have the necessary power supply.

a>Familiar with the equipment and operation.

b>Disconnect the power.

c>Before proceeding with this procedure, ensure that:

-If necessary, mechanical operating equipment should facilitate the operation of refrigerant storage tanks.

-All personal protective equipment is effective and can be used correctly.

-The entire recycling process should be conducted under the guidance of qualified personnel. Recycling equipment and storage tanks should meet the appropriate standards.

d>If possible, vacuum the cooling system.

e>If the vacuum state is not reached, extraction should be performed from multiple places to extract the refrigerant in each part of the system.

f>Ensure that the volume of the tank is sufficient before beginning recovery.

g>Start and operate the recycling equipment according to the manufacturer's operating instructions.

h>Do not talk about tanks being overfilled. (Liquid injection volume does not exceed 80% of the tank volume.)

i>The maximum working pressure of the tank must not be exceeded even for a short period of time.

j After the tank filling is completed and the working process is completed, ensure that the tank and equipment are quickly removed and all shut off valves on the equipment are closed.

k>The recovered refrigerant must not be injected into another refrigeration system until it has been purified and tested.

J. Recycling

The refrigerant in the system needs to be removed during maintenance or scrap. It is recommended that the refrigerant be completely removed.

When loading the refrigerant into the tank, use only a dedicated refrigerant tank. It is necessary to ensure that the capacity of the tank is compatible with the amount of refrigeration injection in the entire system. All tanks intended to be used for refrigerant recovery and are identified with this refrigerant (ie refrigerant recovery dedicated tanks). Tanks should be fitted with pressure relief and shut-off valves and in good condition. If possible, empty storage tanks should be evacuated and kept at room temperature before use.

The recovery equipment should maintain a good working condition, and the equipment operation instructions should be provided for easy reference. The equipment should be suitable for the recovery of flammable refrigerants. In addition, there must be qualified weighing instruments that can be used normally. The hose should be connected using a leak-free, releasable joint and keep it in good condition. Before using the recycling equipment, check whether it is in a good condition, whether it is well maintained, and all the electrical components are sealed to prevent the fire from leaking once the refrigerant leaks. If in doubt, consult the manufacturer.

Recovered refrigerant should be contained in the used storage tank, attached with shipping instructions and returned to the chiller manufacturer. Do not mix the refrigerant in the recovery equipment, especially the storage tank.

If you remove the compressor or remove the compressor oil make sure that the compressor is evacuated to a suitable level to ensure that there is no residual flammable refrigerant in the lubricant. Evacuation is performed before the compressor returns to the supplier. Only use electric heating to heat the compressor housing to speed up this process. When the oil is discharged from the system, safety should be ensured.

Technical data

Model No.:	MDB-16160HIW/MDB-16161HIWR/MDB-16162HIWC MDB-16163HIWB/MDB-16164HIWG
Dehumidify capacity:	16L/Day (30°C RH80%)
	8L/Day (26.7°C RH 60%)
Rated Voltage:	AC 220-240V
Rated Frequency:	50Hz
Max.power input	360W
Rated Input power:	245W
Tank Capacity:	2.5L
Air Volume:	135m ³ /h
Noise Level:	41dB(A)/max value
Refrigerant:	R290/65g
Net weight:	11kgs
Suction pressure:	0.7MPa
Discharge pressure:	3.2MPa

NOTICE ABOUT RECYCLING



Your product is designed and manufactured with high quality materials and components which can be recycled and reused. This symbol means that electrical and electronic equipment, at their end-of life, should be disposed of separately from your household waste. Please dispose of this equipment at your local community waste collection/recycling centre.

In the European Union there are separate collection systems for used electrical and electronic products.

Please help us to conserve the environment we live in!

DECLARATION OF CONFORMITY

Herewith, we state that this product, complies with the requirements of below directives:

EMC-Directive : 14/30/EU

Low Voltage Directive : 14/35/EU

ROHS directive : (EU) 15/ 863

CE Marking: 93/68/EEC



The detailed declaration of conformity can be found at www.morris.gr

WIFI INSTRUCTIONS MANUAL



BEFORE YOU START

- Ensure your router provides a standard 2.4ghz connection.
- If your router is dual band ensure that both networks have different network names (SSID). The provider of your router / ISP will be able to provide advice specific to your router.
- Place the dehumidifier as close as possible to the router during setup.
- Once the app has been installed on your phone, turn off the data connection, and ensure your phone is connected to your router via wifi.

DOWNLOAD THE APP TO YOUR PHONE

Download the "TUYA SMART LIFE" app, from your chosen app store. Alternatively, you could also download the "TUYA Smart" app which is also compatible, but has some slight differences in the layout.

REMARK: Alternatively, you can use the TUYA Smart application, which has a similar layout and functions

REGISTER THE APP

1. Click on the register button at the bottom of the screen
2. Press "Agree" to the Privacy Policy.

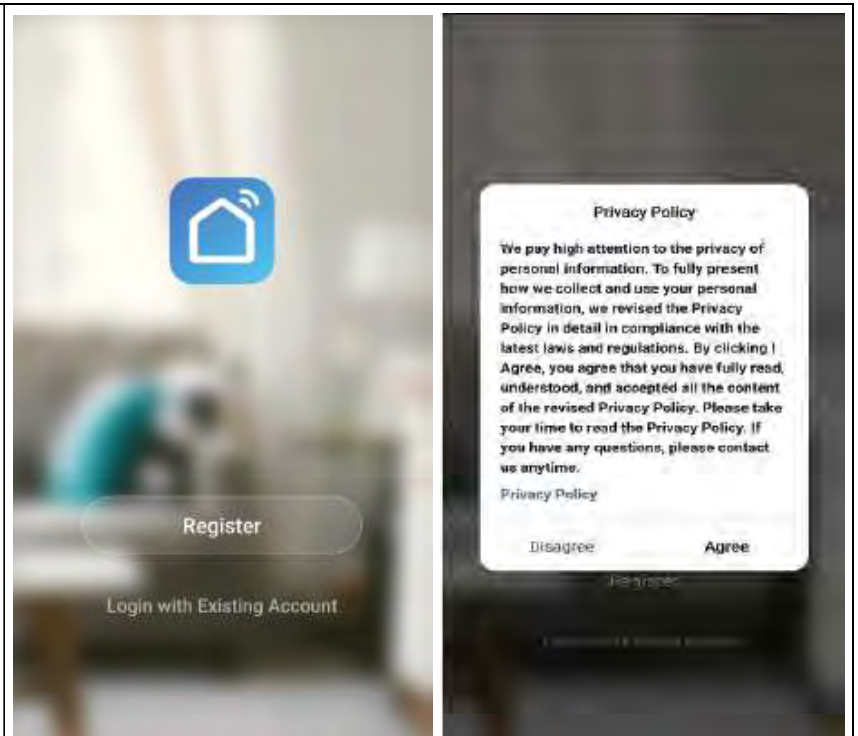

3. Enter either your mobile phone number or email address to receive a verification code, and press next



4. Once you have received the verification code, enter it and create a password in the lower box before pressing confirm.

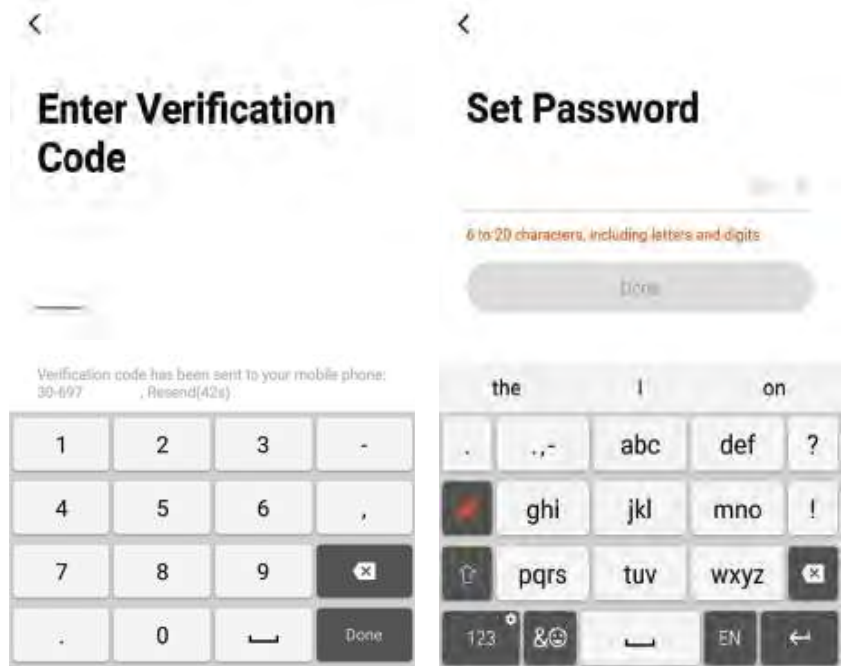

Remark: the verification code shall be sent to you either by sms or by e-mail message, depending on the registration method you have selected above.

CONNECTION METHODS AVAILABLE FOR SETUP

This smart device has two different setup modes, "Add Manually" and "Search by Device"

Before starting the setup, please ensure that your dehumidifier is placed as close as possible to your wifi-router.

ENTERING CONNECTION MODE

To enter connection mode on your dehumidifier, press and hold MODE button for 3" until you hear the sound. The WIFI indication will start flashing

CONNECTING THROUGH THE "ADD MANUALLY" TAB

Before initiating the connection, make sure the WIFI is ON and that the relative indication is flashing. If not, press again and keep pressed for 3 seconds the MODE button, while also ensure your phone is connected to the wifi network.

<p>1. Open app and click "+" to add device</p>	 A screenshot of a mobile application interface. At the top right, there is a blue plus sign icon. In the center, there is a faint image of a dehumidifier with the text "No devices" below it. A prominent blue button with the text "Add Device" is centered below the image. At the bottom, there is a navigation bar with four icons: a home icon, an envelope icon, a dehumidifier icon, and a plus sign icon.
--	---

2. Tap on the top left the "Add Manually" option. On the left side scroll down to "Small Home Appliances". Select the type of device as "Dehumidifier"

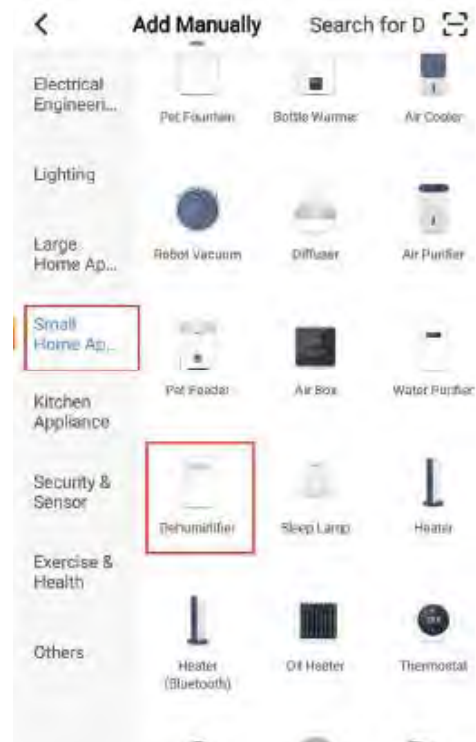

3. Ensure the wifi light on the dehumidifier is flashing quickly (if not, hold the mode button for 3 seconds, then press the button at the bottom of the screen to confirm.



4. Select your home network, enter your wifi password and press confirm.

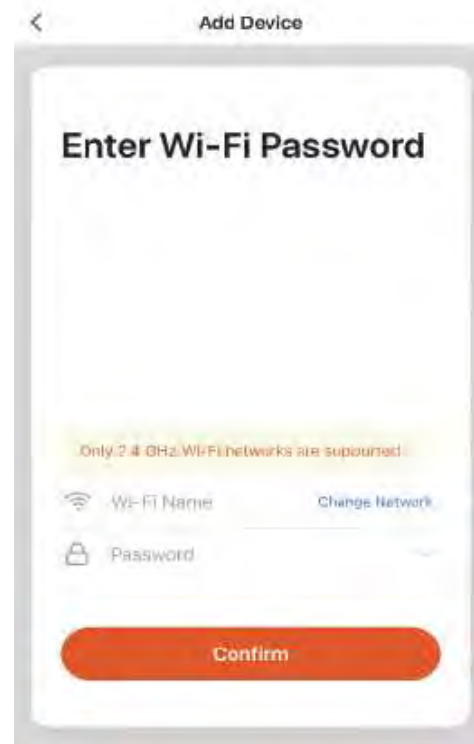

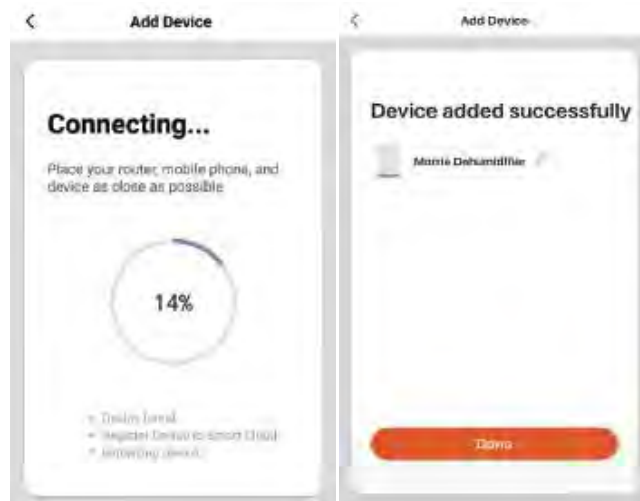

5. This will then transfer the settings to the dehumidifier. Wait until the connection has been completed successfully. If the connection fails, retry. If the connection is still failing please review the troubleshooting section for further help. Once the connection has been completed, your device will appear on the screen. Press DONE button to complete the process.



CONNECTING USING THE "SEARCH FOR DEVICE" TAB

Before initiating the connection, make sure the unit is switched on, with the connection light flashing. If not, press the MODE button again and keep it pressed for 3 seconds, while also ensure that your phone is connected to the wifi network.

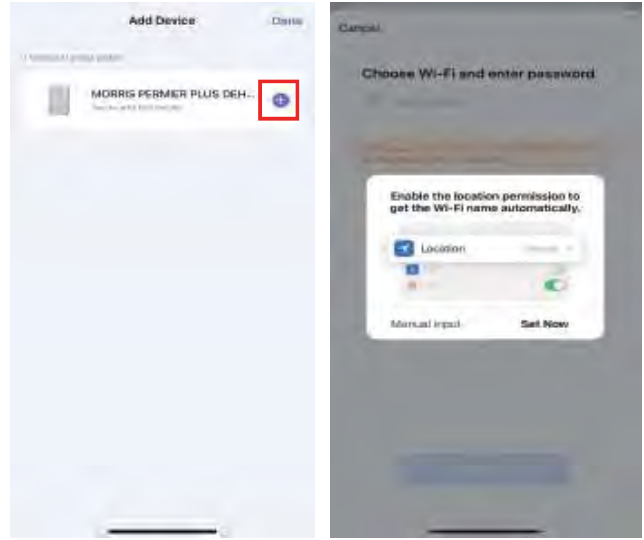
<p>1. Turn on Bluetooth.</p>	
<p>2. Ensure the connection light on the dehumidifier is flashing. Add discovering device.</p>	
<p>3. Click “+” to add device. Make sure that access location is enabled.</p>	

4. You should be seeing the name of your home network, to which your mobile device should already be connected as well. Enter the password in the relative field and press Confirm.

Important: Only 2.4GHz Wi-Fi networks are supported.



5. The connecting of the device will start.

If this fails, retry. If the connection is still failing review the trouble shooting section help.



6. Once the connecting is completed, press the "Done" button to complete the linking.

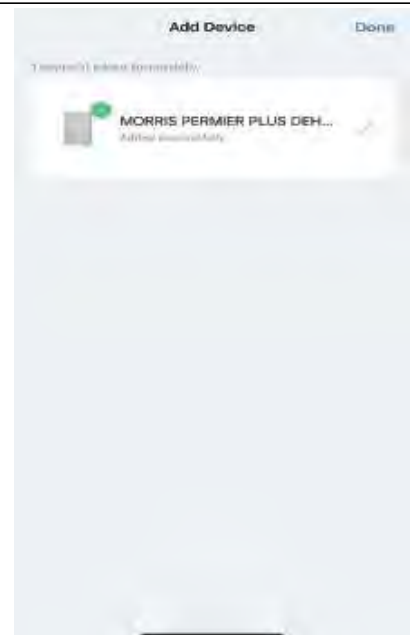

CONTROLLING YOUR DEVICE THROUGH THE APP

Now that your dehumidifier is linked up to your network, you can control it from your phone. From the main control screen you can turn your device on and off by sliding on the power icon on the upper side of the device.

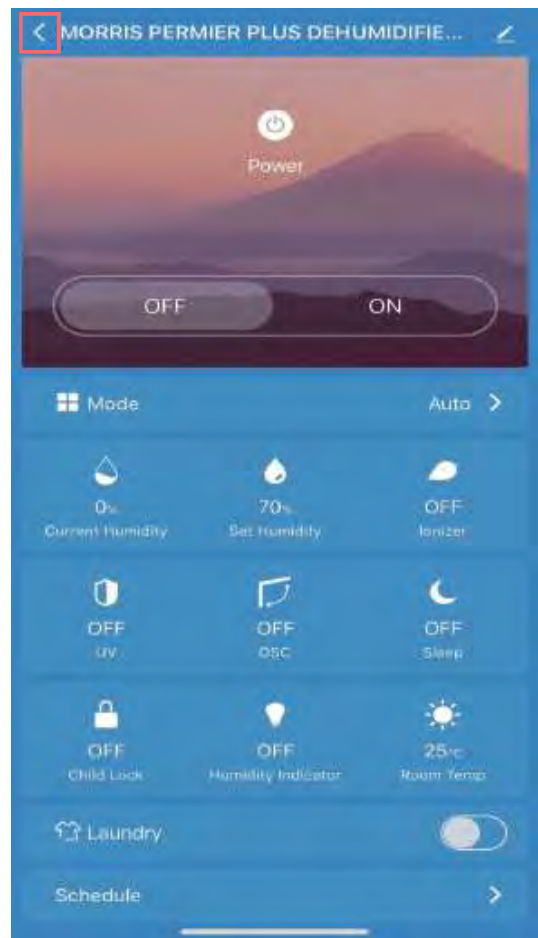

Press the top left button to go back to the last page. There are four tabs at the bottom of the main menu of the application allowing you to swap between Home, Scene, Smart, Me options



Press the button on top right to enter the Device Details Page

PROFILE TAB

The profile tab gives you the option to edit both your details, and use the added features of the unit.

When further settings can be set, three dots appear on the screen (...)

CHANGING THE NAME OF YOUR DEVICE

Tap on the pencil icon on the top right corner. The top option allows you to change the name of the device to something relevant to the use of the product.

Click "Location" and assign a location to the dehumidifier. Example: Bedroom 1, Dining Room etc. and tap save. Use the arrow on top left to return to the operation screen.

SHARE DEVICE

This allows you to share access to the controls of your dehumidifier with friends and family.

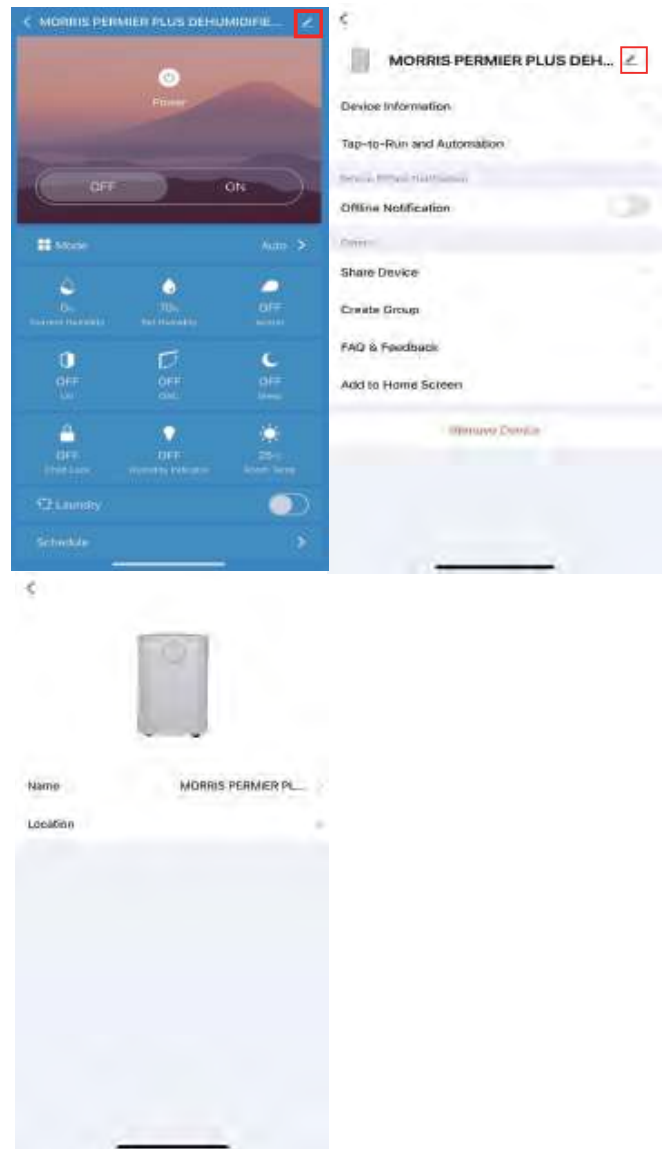

DEVICE SHARING SET UP

The person you add will need to have the TUYA's APP installed on their phone.

Open the APP and choose the appliance. Tap the 'pen' icon in the top right corner of the screen.

Tap 'Share Device' to enter the number of the person you want to include or tap the phone icon to select the persons phone number from your contacts. Tap "Confirm" to complete the addition. REMARK: The invitation for the device sharing must be sent to the details of an existing registered user at TUYA Smart Life.

DEVICE SHARING CANCELLATION

Tap 'Shared Devices' to delete the number of the person you want to cancel
Tap "Confirm" to complete the addition.

NOTE: There can only be one user operating the dehumidifier at a time. The APP needs to be closed on all other devices to enable the sharing to work.

NOTE: If someone else sets up their phone on the same dehumidifier without using the "Share Device" ,the original phone will be disconnected and the dehumidifier will disappear from the device list.

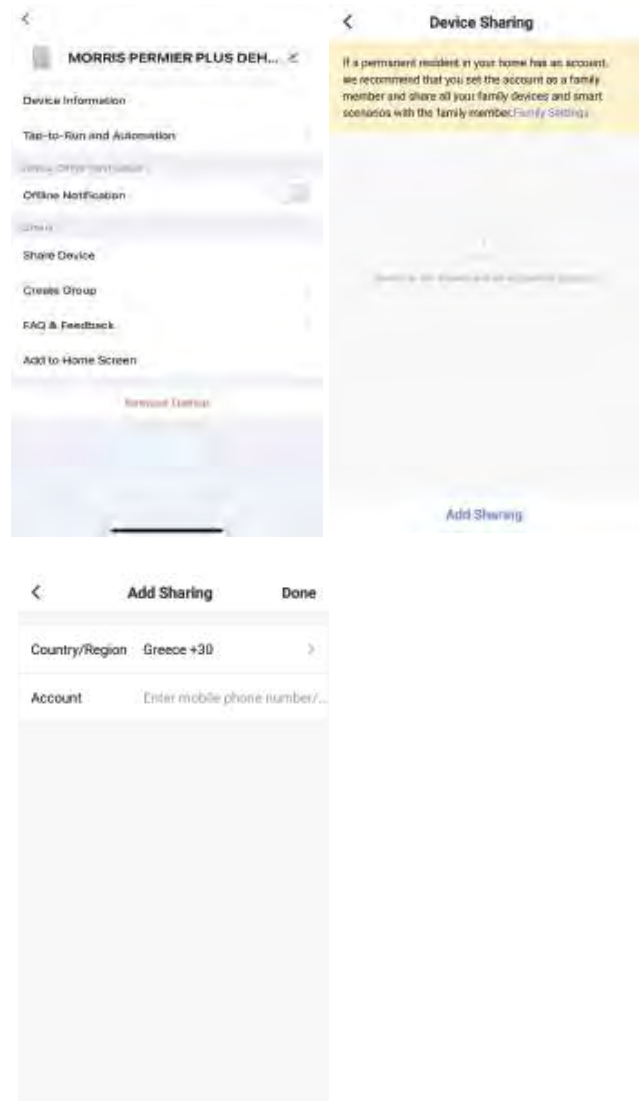

Mobile phone remote operation (connect dehumidifier power and turn on the side switch, so that the dehumidifier is in standby mode).

Open the "TUYA SMART LIFE" APP to select the dehumidifier (when using one mobile phone to control multiple appliances, you need to select the dehumidifier to be operated).

- Select the dehumidifier to be operated and enter the operation interface.

If the power slider is highlighting OFF, this indicates that the dehumidifier is in the OFF/Standby setting.

- Tap the ON icon and the dehumidifier will turn on.
- You can now control the dehumidifier.

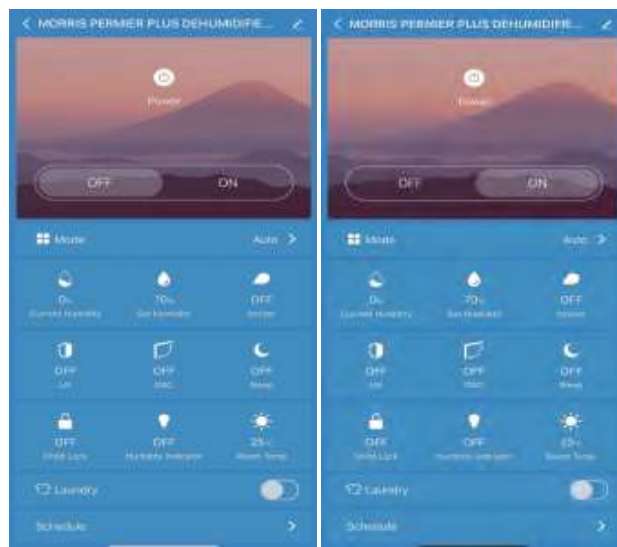

OFF highlighted – Unit is Off / ON highlighted - Unit is On

- To turn the dehumidifier off again tap the OFF icon and the dehumidifier will revert to the dark screen.

HUMIDITY SETTING:

The required humidity can be set from 35-80%. Tap the 'Set Humidity' button and then scroll through to set the required humidity then press OK to return to the main screen.

When the set humidity is lower than the relative humidity, the dehumidifier begins to operate. If the set humidity is above the relative humidity the dehumidifier will be in standby mode and will not operate until the relative humidity increases above the set humidity.

The current humidity is shown on the left of the main screen.

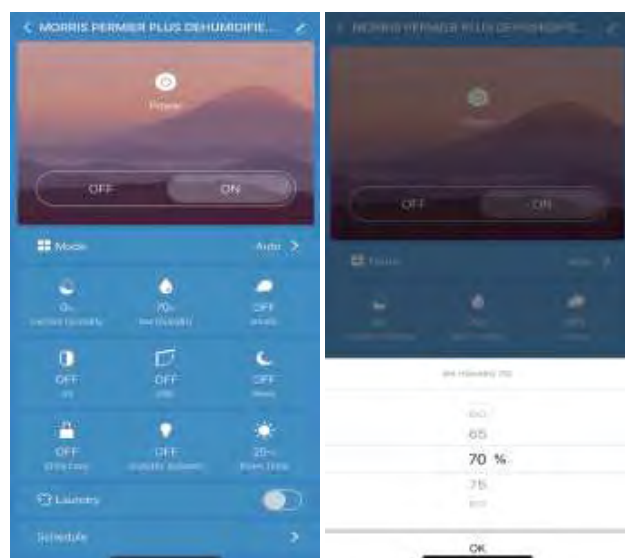

The current room temperature is displayed at the bottom of the screen.



MODE

Mode can be set to Auto, Fan, High or Low.

Press the 'Mode' icon to set the required operating mode.

Auto Mode: Maintains the room at an ideal domestic environment humidity of 50-55% relative humidity (RH) while saving electricity. The compressor will work until the desired humidity is reached and will then stop. The unit will operate and remain in this mode by default when turned on. The desired humidity cannot be changed in this mode.

Fan Mode: This mode only uses the fan – No moisture will be extracted while this mode is in operation. Filters like the "UV" and "Plasma Ioniser" can be used in this mode to improve the quality of the air processed and emitted through the unit

High Mode: This mode ensures the air in the room is processed and RH is correctly measured with the operating at fan at a higher speed. Adjust your desired humidity level by tapping the 'Set Humidity' button to scroll through and select your desired humidity.

Low Mode: This mode ensures the air in the room is processed and RH is correctly measured with the operating at fan at a lower speed. Adjust your desired humidity level by tapping the 'Set Humidity' button to scroll through and select your desired humidity.

IONIZER BUTTON (Plasma Ionisation Function)

Pressing this button turns on the "Plasma Ionizer" function. The ionizer can refresh the air while killing viruses, dust mites, mould, and airborne allergens. To turn off this function, press the button again.

UV BUTTON (for Air Purification)

Pressing this button turns on the "UV" function. The germicidal UV light improves the air quality by destroying germs, bacteria, and fungi. To turn off the "UV", press the button again.

HUMIDITY INDICATOR

This turns the colour changing humidity indicator on the front of the unit on and off. The indicator will turn on automatically when the appliance is turned on. You can turn off the light by pressing the Humidity Indicator Button and enter the device in SLEEP mode.



OSCILLATING BUTTON

Press this button to turn on the "OSCILLATING" function.
To turn off this function, press the button again.



SLEEP BUTTON

Press the SLEEP button to activate the SLEEP mode.
The indicator light will illuminate.
Press the SLEEP button again to quit the SLEEP mode,
then the device will work as per the last setting before
the SLEEP mode.



CHILD LOCK BUTTON

Press this button to enter the child lock mode, the
child lock indicator lights up, and all touch button
touches are invalid; after pressing this button again,
the child lock indicator light is off, and all touch
button touches are effective again.



LAUNDRY

Slide this button to the right and the color become
green, the laundry function is turned on;
Slide this button to the left, this function is turned off.



TIMER (SCHEDULE)

In the main APP screen, scroll down to find the Schedule button under the dehumidifier controls.

Press this button to set smart timer.

The timer in the APP has far more functionality than the timer button on the unit.

Press the button to add a 'Schedule', then press 'Add Schedule' at the bottom.

Select whether you want the unit to turn Off or On. You can then set down to the minute when you want the unit to turn off or on.

You can also set the timer to 'Repeat' the operation for specific/multiple days.

When you have finished your desired settings, press 'Save' to confirm and go back to the main APP screen.

You can also set up a Timer Schedule when the unit is in the Off/Standby setting.

Press Schedule and follow instructions above.

To remove a set schedule, if you have Android long press on the schedule, while in IOS slide left and press 'Delete' when the confirmation prompt comes up.

Important Note: Make sure the Smartphone or Tablet Clock that you are using has the right time you are providing from the connection network to the Internet. Possible delay or non-activation of the timer may be caused by an incorrect time setting on the device you are using.

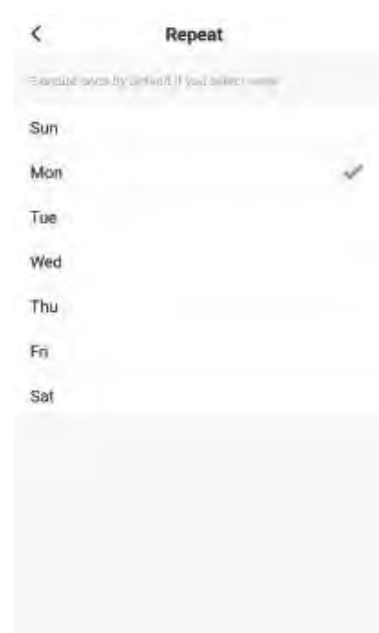
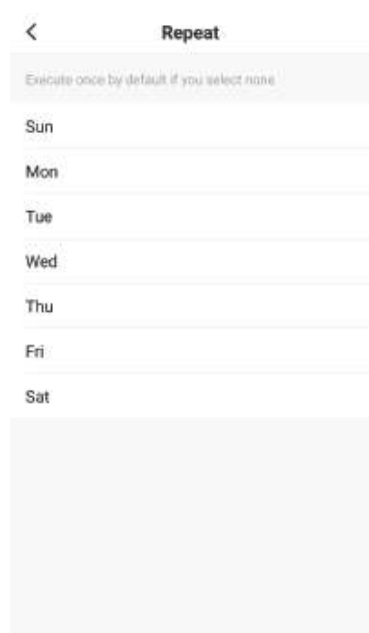
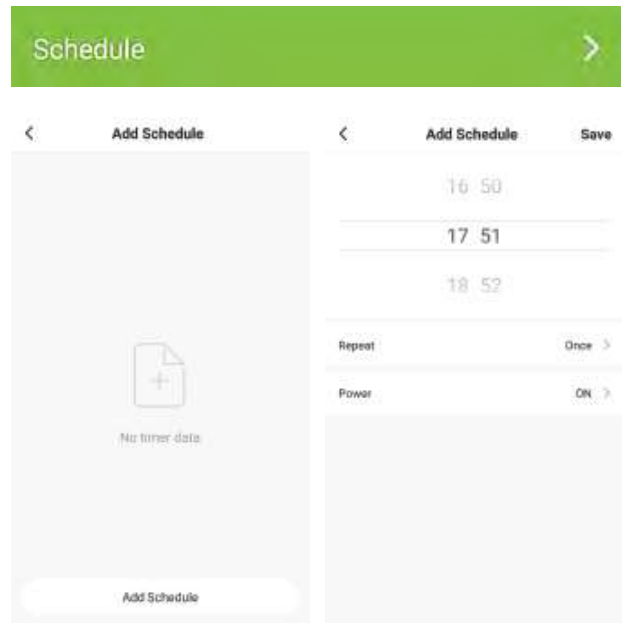

ADDING ADDITIONAL DEHUMIDIFIERS

You have the ability of adding additional devices to be controlled by this application. This feature is particularly convenient in case you have more than one of our dehumidifiers, or in case you have other TUYA powered smart appliances in your possession, since it allows you to control them all at the same time.

From the “Devices” page of the APP press add device symbol “+” on the top right corner and follow the below listed steps to pair the new appliance.

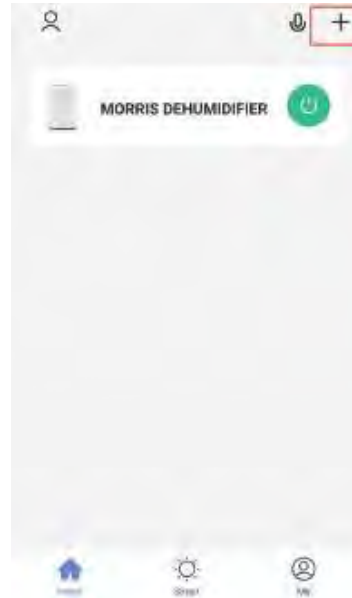

Choose/confirm which WiFi to connect to.
Note: your phone may pick up other WiFi signals (eg. neighbours) so you will need to choose.

Enter your WiFi password



Make certain that the device to be added is already in "Wifi connectivity" status. In case of a MORRIS dehumidifier, revert to the connectivity section in the previous pages. In case of another TUYA powered smart device please revert to its own connectivity manual.

The phone will now connect to the dehumidifier. Ensure you have a good strong signal from your WiFi router.

Note: The WiFi indicator on the dehumidifier screen may disappear during this pairing process.

Once complete the screen showing the device has been successfully added will appear.

Rename the dehumidifier if desired.

Tap "Done" to continue.

Your Devices list will then show the additional dehumidifier that you have paired

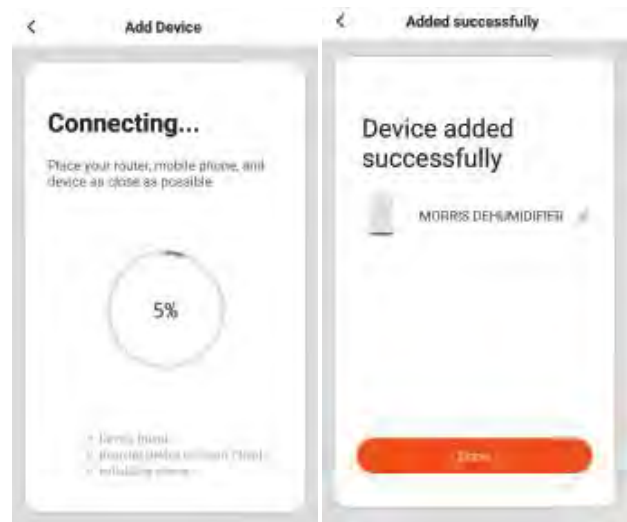

TROUBLESHOOTING

1. Check whether the device is powered on and is in the correct standby mode, if not please refer to the Changing between connection types section.
2. Ensure the wifi password has been entered into the app correctly (Case sensitive)
3. Check that the phone is connected to the wifi you are connecting the device to.
4. Ensure the network you are connecting it to is 2.4Ghz (5Ghz wifi networks are not supported), and that there is a strong wifi signal to the item.
5. Check the settings on the router. Encryption should be WPA2-PSK and authorisation type should be set to AES
6. If you are unable to connect through the quick connection method, please try following the guide for connecting the AP Mode.

DISCLAIMER:

All above instructions and illustrations are offered based upon the layout of TUYA's Smart Life application at the date of publishing.

Actual layout of the application, its graphics, or exact menus at the time of installation may differ.

This is the result of the applications constant updating so as to improve the user experience, resolve potential bugs, or even add more features.

In case of any difficulty, please check our web-page for an updated version, or contact our after sales department.

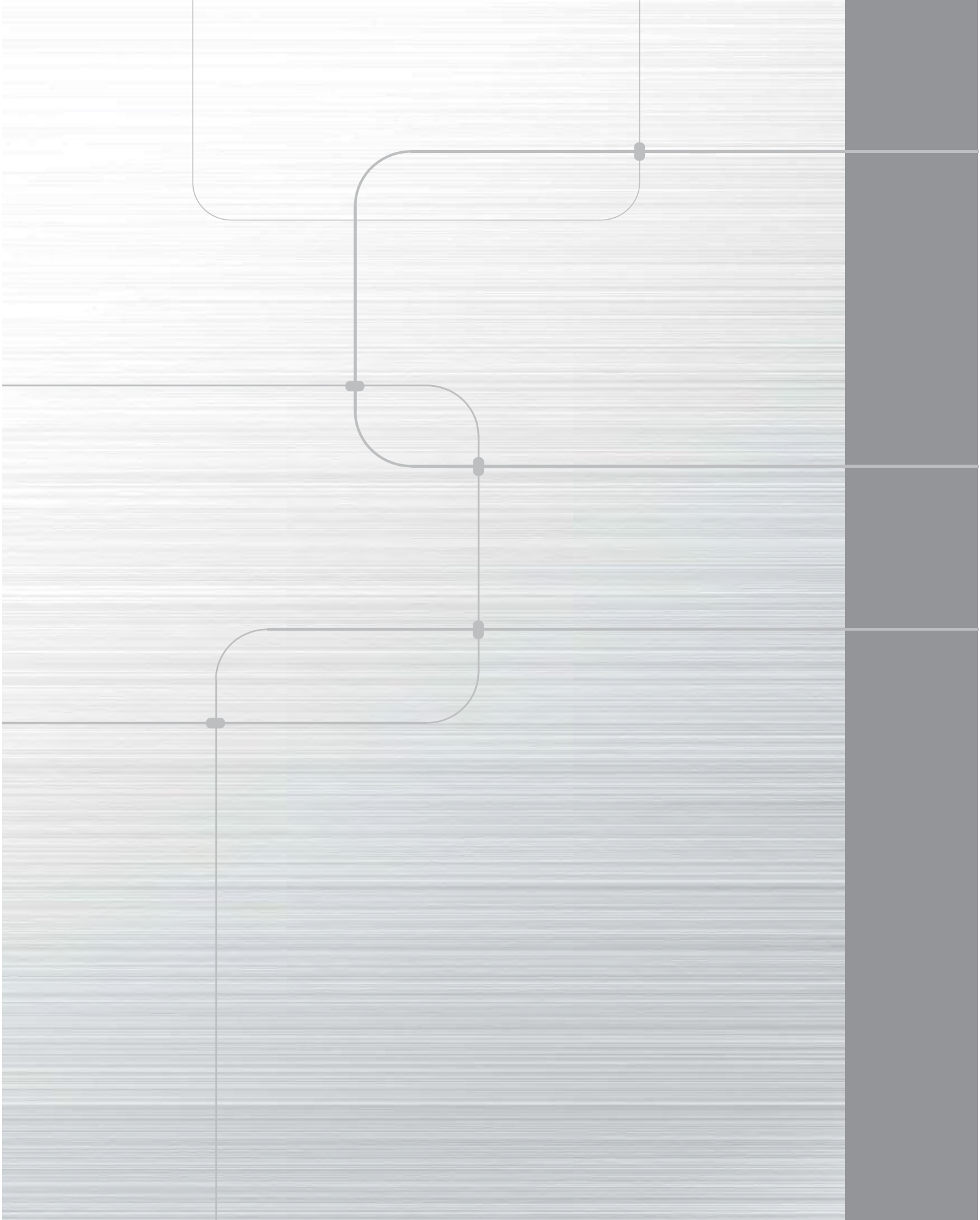

Exclusive Distributor
Amiridis-Savvidis S.A
87A, 17is Noemvriou Str
P.C.55535 | Pylea | Greece
T:2310 944944