

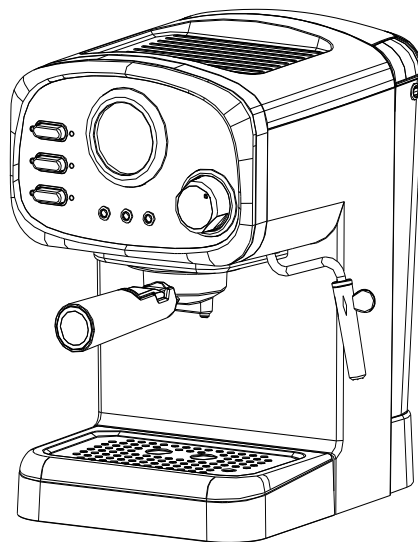

MORRIS

ESPRESSO COFFEE MAKER

INSTRUCTIONS MANUAL



MODELS:

R20806EMC / R20807EMG

R20808EMR / R20809EMB

R20822EMK

Read this manual thoroughly before using and save it for future reference.
Pictures in this manual are just indicative.

IMPORTANT SAFEGUARDS

Before using the electrical appliance, the following basic precautions should always be followed including the following:

1. Read all instructions.
2. Before using check that the voltage of wall outlet corresponds to rated voltage marked on the rating plate.
3. This appliance has been incorporated with a grounded plug. Please make sure the wall outlet in your house is well earthed.
4. To protect against fire, electric shock and injury to persons do not immerse main parts of the product, cord, plug, in water or other liquid.
5. The appliance must not be immersed.
6. Remove plug from wall outlet before cleaning and when not in use. Allow appliance cool down completely before taking off, attaching components or before cleaning.
7. Do not operate any appliance with a damaged cord or plug or after the appliance malfunctions, or is dropped or damaged in any manner. Return appliance to the nearest authorized service facility for examination, repair or electrical or mechanical adjustment.
8. The use of accessory attachments not recommended by the appliance manufacturer may cause fire, electric shock or injury to persons.
9. Place appliance on flat surface or table, do not hang power cord over the edge of table or counter.
10. Ensure the power cord do not touch hot surface of appliance.
11. Do not place the coffee maker on hot surface or beside fire in order to avoid to be damaged.
12. To disconnect, remove plug from wall outlet. Always hold the plug. But never pull the cord.
13. Do not use appliance for other than intended use and place it in a dry environment.
14. Be careful not to get burned by the steam.
15. Do not touch the hot surface of appliance (such as steam wand, and the steel mesh just boiling). Use handle or knobs.
16. Do not let the coffee maker operate without water.

IMPORTANT SAFEGUARDS

17. DO NOT remove the metal funnel while brewing coffee. Please remove the metal funnel to make additional coffee after finish brewing for more than 10 seconds. Caution should also be taken while removing the metal funnel since the metal parts will be hot. Please make sure to hold it by the handle. Use the filter retention clip to secure the filter, then dispose the grounds. Caution should be taken when moving a unit with hot liquids.
18. Connect the plug to the wall outlet before using and turn any switch off before plug is removed from wall outlet.
19. This appliance can be used by children aged from 8 years and above if they have been given supervision or instruction concerning use of the appliance in a safe way and if they understand the hazards involved. Cleaning and user maintenance shall not be made by children unless they are older than 8 and supervised. Keep the appliance and its cord out of reach of children aged less than 8 years.
20. Appliances can be used by persons with reduced physical, sensory or mental capabilities or lack of experience and knowledge if they have been given supervision or instruction concerning use of the appliance in a safe way and understand the hazards involved.
21. Children shall not play with the appliance.
22. This appliance is intended to be used in household and similar applications such as:
 - staff kitchen areas in shops, offices and other working environments;
 - farm houses;
 - by clients in hotels, motels and other residential type environments;
 - bed and breakfast type environments.
23. Do not use outdoors.
24. Save these instructions.

KNOW YOUR COFFEE MAKER

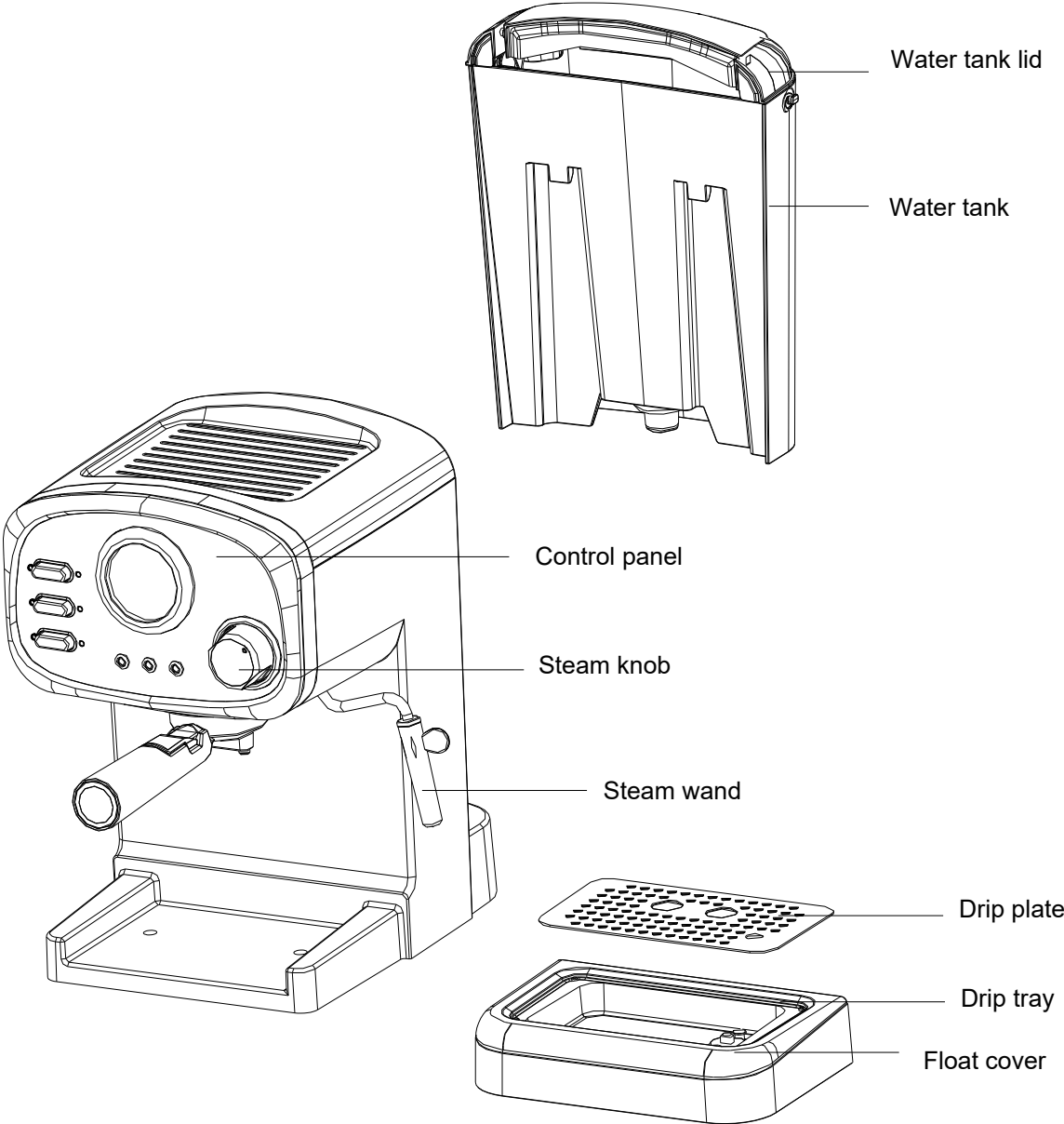

CONTROL PANEL

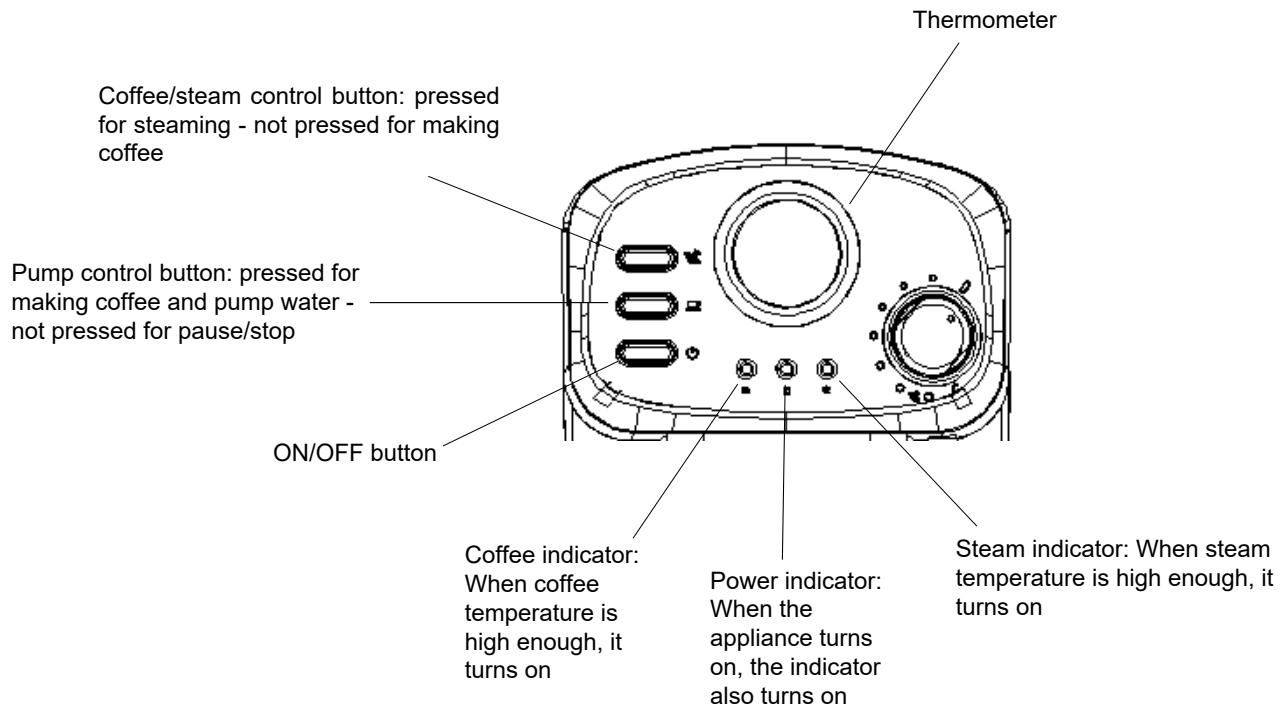

INSERTING THE FILTER

1. To insert the selected filter in the porta-filter, make sure to align the notch on the filter with the groove inside the porta-filter.

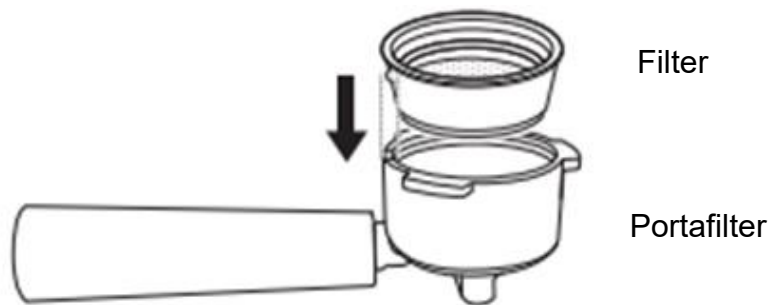

2. Turn the filter to the left or right to lock in place. This will help secure the filter in the portafilter.

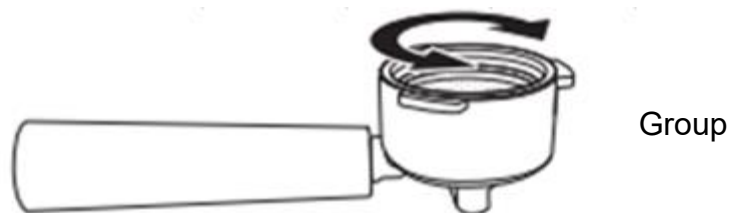

BEFORE THE FIRST USE

To ensure the first cup of coffee tastes excellent, you should rinse the coffee maker with warm water as following:

1. Pull out the water tank of the coffee maker. Pour water into the water tank, the water level should not exceed the "MAX" mark in the tank, then insert it back into the coffee maker.
2. **Note:** The appliance is supplied with a removable tank for easy cleaning. Please fill the tank with water first, and then insert the tank into the appliance.
3. Set the steel filter into the portafilter (without coffee in the filter), then put the porta-filter under the metal funnel holder (see Fig.1), and turn it anticlockwise until it is fixed tightly (see Fig.2 and Fig.3).

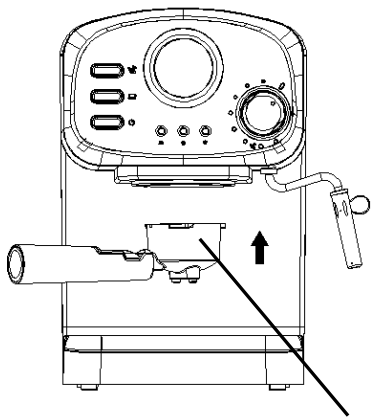

Metal funnel holder

Fig.1

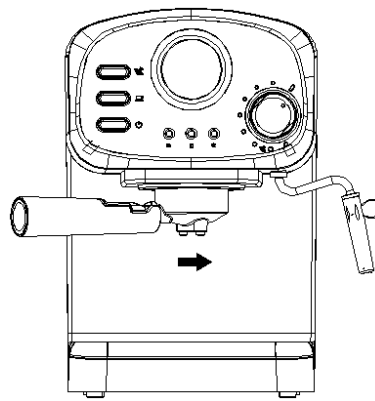

Fig.2

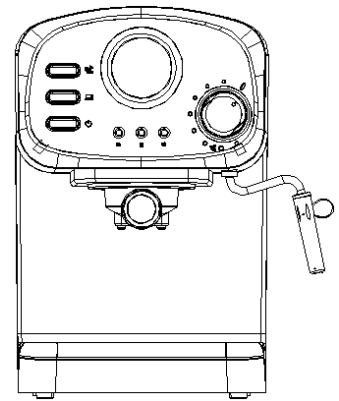









Fig.3

4. Place an empty espresso cup on the drip plate. Make sure the steam knob is at the "O" position.
5. **Note:** The appliance is not equipped with any cup or jug.
6. Connect to power source and press ON/OFF button "⏻" to turn on the unit. The power indicator (red) will be illuminated.
7. Press the pump control button "☞", the pump will pump water. When water starts flowing out, you may close the pump by pressing the pump control button "☞" again.
8. Make sure the coffee/steam button "☞" / "☞" is not pressed and wait for a moment. The appliance begins preheating. When coffee indicator (green) illuminates, it means that the preheating is finished.
9. Press the pump control button "☞" again and water will flow out.
10. After water has flown for 1 minute, press the pump control button "☞". Discard the water that has been collected in the cup, then clean the water tank thoroughly. Now you can start brewing coffee.





Note: There may be noise when pumping the water for the first time. This is normal, as air is released in the appliance. After about 20sec., the noise will disappear.

PREHEATING

To make a cup of good hot Espresso coffee, it is recommended to preheat the appliance before making coffee, including the porta-filter and a cup, so that the coffee flavour will not be influenced by the cold parts.

1. Remove the removable water tank and fill it with water. The water level should not exceed the "MAX" mark in the tank. Then insert the tank into the appliance properly.
2. Set the steel filter into the porta-filter (without coffee in the filter), then put the porta-filter under the metal funnel holder (see Fig.1) and turn it anticlockwise until it is fixed tightly (see Fig.2 and Fig.3).
3. Place an espresso cup on the removable cup shelf.
4. Connect the appliance to the power supply. Make sure the steam knob is at the "O" position.
5. Press the ON/OFF button "  " to turn on the unit. The power indicator (red) will illuminate. Make sure the coffee/steam buttons "  " / "  " are not pressed.
6. Press the pump control button "  ". When water starts flowing out, close the pump immediately by pressing the pump control button "  " again. The purpose of this step is to pump the water of the tank into the housing.
7. When the coffee indicator (green) is illuminated, press the pump control button "  " again and hot water will be flowing out.
8. After water has flown for 20sec., press the pump control button "  ". The preheating is finished.

MAKE ESPRESSO COFFEE

1. Remove the porta-filter by turning it clockwise.
2. Add ground coffee in the steel filter with the measuring spoon. A spoon of ground coffee powder can make about a cup of top-grade coffee. Then press the ground coffee powder tightly with the tamper.
3. Set the filter into the porta-filter, then put the porta-filter under the metal funnel holder (see Fig.1) and turn it anticlockwise until it is fixed tightly (see Fig.2 and Fig.3).
4. Pour out the hot water from the cup (from the preheating step) and place the hot cup on the removable cup shelf.
5. Make sure the steam knob is at the "O" position and the coffee/steam button "  " is not pressed.
6. When coffee indicator (green) is illuminated, press the pump control button "  ", wait for a moment, and then coffee will start flowing out.
7. You can press and release the pump control button "  " to the higher position manually when desired coffee is obtained or the color of coffee changes weak obviously.
8. After finish brewing, press the ON/OFF button "  ". The power indicator and coffee indicator will turn off, the coffee maker will stop working and your coffee will be ready.

WARNING: do not leave the coffee maker unattended during making coffee, you might need to operate it manually sometimes!

Note: During brewing coffee or making steam, it is normal if the ready indicator extinguishes. This means that the heater is heating up to keep the temperature at the standard range.

9. Remove the portafilter by turning it clockwise; then pour the coffee residue out with the steel filter pressed by the press bar.
10. Let them cool down completely, then rinse under running water.

MAKE CAPPUCCINO

You can get a cup of cappuccino by topping a cup of espresso with frothing milk.

Note: During making steam, the metal funnel must be assembled in position.

Method:

1. Prepare espresso first, using a suitable cup/container, according to the part "MAKE ESPRESSO COFFEE". Make sure the steam knob is at the "O" position.
2. Press down the coffee/steam button "☕" to the lower position and wait until the steam indicator (yellow) illuminates.
3. Fill a jug with about 100 grams of milk for each cappuccino cup you want to prepare. It is recommended to use cold, whole fat milk.
4. In order to get better quality of frothing milk, it is recommended to keep steam knob at open position for approx 15sec. , since the initial steam contains too much water. Then turn the knob at "O" position and conduct next step.
5. Insert the steam wand into the milk about two centimeters, then turn the steam knob slowly anticlockwise. Steam will begin coming out from the steam wand. Frothed milk is produced by moving vessel up and down for several times.

Note: Never touch steam outlet during steam jetting - be careful not to get burned.

Note: Never turn the steam knob rapidly. The steam might accumulate in short time which may increase the potential of risk of explosion.

6. When frothing milk is ready, you can turn the steam knob to the "O" position.
7. After producing frothing milk (every time), please follow the procedure below to protect the steam outlet from being blocked: put an empty jug under the steam band, then turn on the steam knob and press once the pump control button "☑". The pump will pump water. After water is flowing out for 30 sec., press again the pump control button "☑". Finally clean the steam outlet with a wet sponge. Be cautious not to get burned!
8. Press and release the ON/OFF button "⏻" to turn off the appliance.
9. Pour the frothed milk into the prepared espresso cup. Now your cappuccino is ready. Sweeten if desired, and sprinkle the froth with a little cocoa powder or cinammon.









Note 1: If the steam outlet is blocked, please follow the procedure below: (1) turn the steam knob to "O" position and let coffee maker cool down for about half an hour, (2) poke the steam outlet for several times with a needle of about 1mm diameter, (3) press once the coffee/steam button "☕" and turn on the steam knob to check if the appliance can produce steam normally when the steam indicator (yellow) illuminates. Please contact the service department if the appliance still cannot produce steam after above.

Note 2: after steaming, it is recommended to allow coffee maker to cool down at least for 5 min. before making coffee again. Otherwise burnt odor may occur in your Espresso. If you want to make coffee immediately, follow the next steps: (1) press and release the steam button "☕" once, then dip the steam wand into a cup; (2) press the pump control button "☑" once and turn on the steam control knob (there will be water flow out from steam wand). After the ready indicator extinguish, press and release the pump control button "☑" again, then turn the steam control knob to "O" position. When the ready indicator illuminates, you can start to brew coffee again.



FROTHING MILK / PRODUCING STEAM TO HEAT LIQUIDS

The steam wand can be used to froth milk and make hot beverages like drinking hot chocolate, water or tea.

Method:

1. Remove the removable water tank and fill it with water. The water level should not exceed the "MAX" mark in the tank. Then insert the tank into the appliance properly.
2. Connect the appliance to power supply.
3. Press down the ON/OFF button "  " to turn on the unit. The power indicator (red) illuminates.
4. Press once the pump control button "  ". Make sure the coffee/steam button "  " is not pressed. The pump will pump water. When water is flowing out, close the pump immediately.
5. Press down the coffee/steam button "  " to the lower position and wait for a moment, the appliance begins to heat until the (yellow) lamp illuminates, which means that heating is finished.
6. Dip the steam wand into the liquid to be heated. If you want to froth milk, dip the steam wand about 2 cm. into milk. Turn the steam knob anti-clockwise slowly to start making steam.
7. When desired result is reached, you can turn the steam knob to "O" position and press the coffee/steam button "  " to the higher position.
8. After producing frothing milk (every time), please follow the procedure below to protect the steam outlet from being blocked: put an empty jug under the steam band, then turn on the steam knob and press once the pump control button "  ". The pump will pump water. After water is flowing out for 30 sec., press again the pump control button "  ". Finally clean the steam outlet with wet sponge. Be cautious not to get burned!
9. Press and release the ON/OFF button "  " to cut off the power source.

Note: If the steam outlet is blocked, please follow the procedure below: (1) turn the steam knob to "O" position and let coffee maker cool down for about half an hour, (2) poke the steam outlet for several times with a needle of about 1mm diameter, (3) press once the coffee/steam button "  " and turn on the steam knob to check if the appliance can produce steam normally when the steam indicator (yellow) illuminates. Please contact the service department if the appliance still cannot produce steam after above.

Note: after steaming, it is recommended to allow coffee maker to cool down at least for 5 min. before making coffee again. Otherwise burnt odor may occur in your Espresso. If you want to make coffee immediately, follow the next steps: (1) press and release the steam button "  " once, then dip the steam wand into a cup; (2) press the pump control button "  " once and turn on the steam control knob (there will be water flow out from steam wand). After the ready indicator extinguish, press and release the pump control button "  ", then turn the steam control knob to "O" position. When the ready indicator illuminates, you can start to brew coffee again.

AUTOMATIC POWER OFF FUNCTION









After pressing ON/OFF button, the appliance will turn off automatically within 25 minutes.

CLEANING AND MAINTENANCE

1. Make sure to unplug this appliance before cleaning and let it cool down completely.
2. Clean housing of coffee maker with moisture-proof sponge often. Clean water tank, drip tray and removable shelf regularly, then dry them.
Note: Do not clean with alcohol or solvent cleanser. Never immerse cord, plug or unit in water for cleaning.
3. Detach the metal funnel by turning it clockwise. Take out and throw away all coffee residue, then clean it with cleanser and rinse with clear, fresh water. Do not wash the metal funnel in a dishwasher.
4. Clean all the attachments with water and dry them thoroughly.

Note: Clean the appliance after every use in order to make it work properly.

REMOVING MINERAL DEPOSITS

1. To keep your coffee maker operating efficiently, internal piping is clean and have the best coffee flavor, every 1-2 months you should clean away the mineral deposits left by the water according to the water quality in your area and the use frequency.
2. Fill the water tank with water and descaler to the max level as indicated on the water level gauge (the proportion of water and descaler is 4:1, the details should be listed in the instructions of descaler). Please use only "household descalers". You may also use citric acid instead of the descaler (the proportion of water and citric acid is 100:3).
3. According to the program of preheating, put the metal funnel (without coffee powder in it) and carafe (jug) in place. Brew water per "PREHEATING".
4. Press down the ON/OFF button "  " to turn on the unit, the power indicator (red) will be illuminated, you should press the pump control button "  " to the lower position, make sure the coffee/steam button "  " is at the higher position, when there is water flowing out and close the pump by pressing the pump control button "  " again, and wait for a moment, the coffee maker begins to be heated.
5. When the ready indicator (green) illuminates, it shows the heating is finish. Press down the pump control button "  " to the lower position and make two cups of coffee (about 2Oz). Then close the pump and wait for 5s.
6. Press down the coffee/steam button "  " to the lower position, waiting for until the yellow indicator is illuminated. Make steam for 2min., then turn the steam knob to the "O" position to stop making steam. Press the ON/OFF button "  " to turn off the unit immediately, make the descalers deposit in the unit at least 15 minutes.
7. Restart the unit and repeat steps 4-6 at least 3 times.
8. Then pressing and release the coffee/steam button "  " to the higher position, when the green lamp is illuminated, press down the pump control button "  " to the lower position to brew until no descaler is left.
9. Then start brewing coffee (without coffee powder) with tap water in the MAX level. Repeat steps 4-6 for 3 times (not necessary to wait 15 minutes in step 6), then brew until no water is left in the tank.
10. Repeat step 9 at least 3 times to make sure the piping is totally clean.

TROUBLESHOOTING

Symptom	Possible Cause	Corrections
Water leaks from the bottom of coffee maker.	There is much water in the drip tray.	Please clean the drip tray.
	There is malfunction of the coffee maker.	Please contact with the authorized service facility for repairing.
Water leaks from the outer side of filter.	There is some coffee powder on filter edge.	Get rid of them.
Acid (vinegar) taste exists in Espresso coffee.	No correct cleaning after cleaning mineral deposits.	Clean coffee maker as per content in "before the first use" for several times.
	The coffee powder is stored in a hot, wet place for a long time. The coffee powder turns bad.	Please use fresh coffee powder, or store unused coffee powder in a cool, dry place. After opening a package of coffee powder, reseal it tightly and store it in a refrigerator to maintain its freshness.
The coffee maker does work any more.	The power outlet is not plugged well.	Plug the power cord into a wall outlet correctly. If the appliance still does not work, please contact with the authorized service facility for repairing.
The steam cannot froth.	The steam ready indicator is not illuminated.	Only after the steam ready indicator is illuminated, the steam can be used to froth.
	The cup is too big or its shape does not fit well.	Use high and narrow cup.
	You have used skimmed milk	Use whole half milk or skimmed milk

Do not take apart the appliance by yourself if the cause of failure is not found. You better contact certified serving center.

NOTICE ABOUT RECYCLING

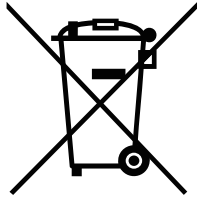

Your product is designed and manufactured with high quality materials and components which can be recycled and reused. This symbol means that electrical and electronic equipment, at their end-of-life, should be disposed of separately from your household waste. Please dispose of this equipment at your local community waste collection/ recycling centre.

In the European Union there are separate collection systems for used electrical and electronic products.

Please help us to conserve the environment we live in!

DECLARATION OF CONFORMITY

Herewith, Amiridis-Savvidis S.A. states that this product, complies with the requirements of below directives:

EMC-Directive: 14 / 30 / EU

Low Voltage Directive: 14 / 35 / EU

ErP Directive 09 / 125 / EC

CE Marking: 93 / 68 / EEC

RoHS Directive: 11 / 65 / EU & 15 / 863 / EU

The detailed declaration of conformity can be found at

www.morris.gr



KALLIOPI KARYDA & CO., LP
87A, 17th Noemvriou str, P.C. 55535
Thessaloniki – Greece
T: +302316006600 | F: +302316006650